

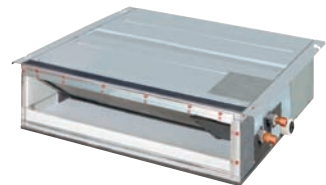

Engineering Data SPLIT

- Heat Pump -

D-Series



INVERTER

DAIKIN AC (AMERICAS), INC.

Split-System Room Air Conditioners D-Series

	Heat Pump	
The Single Split Duct-Free System	FTXS09DVJU	RXS09DVJU
	FTXS12DVJU	RXS12DVJU
	FTXS15DVJU	RXS15DVJU
	FTXS18DVJU	RXS18DVJU
	FTXS24DVJU	RXS24DVJU
The Slim Duct Built-in System	FDXS09DVJU	RXS09DVJU
	FDXS12DVJU	RXS12DVJU

1. Power Supply	3
2. Functions.....	4
3. Specifications	6
4. Dimensions	10
4.1 Indoor Units	10
4.2 Outdoor Units	12
5. Wiring Diagrams.....	14
5.1 Indoor Units	14
5.2 Outdoor Units	16
6. Piping Diagrams.....	17
6.1 Indoor Units	17
6.2 Outdoor Units	18
7. Capacity Tables	20
7.1 The Single Split Duct-Free System	20
7.2 The Slim Duct Built-in System.....	25
7.3 Capacity correction factor by the length of refrigerant piping (Reference)	27
8. Operation Limit.....	28
9. Fan Characteristics	29
10. Sound Level	30
10.1 Measuring Location	30
10.2 Octave Band Level.....	31
11. Electric Characteristics.....	34
12. Installation Manual	35
12.1 Indoor Units	35

12.2 Outdoor Units	63
13.Operation Manual.....	78
13.1 Safety Precautions	78
13.2 The Single Split Duct-Free System FTXS09/12DVJU.....	80
13.3 The Single Split Duct-Free System FTXS15/18/24DVJU.....	105
13.4 The Slim Duct Built-in System FDXS09/12DVJU.....	130
14.Optional Accessories	150
14.1 Option List	150
14.2 Installation Manual	151

Cautions

1. Air conditioners should not be installed in areas where corrosive gases, such as acid gas or alkaline gas, are produced.
2. If the outdoor unit is to be installed close to the sea shore, direct exposure to the sea breeze should be avoided and choose an outdoor unit with anti-corrosion treatment.

1. Power Supply

	Indoor Units	Outdoor Units	Power Supply
The Single Split Duct-Free System	FTXS09DVJU	RXS09DVJU	1 ϕ , 208-230V, 60Hz
	FTXS12DVJU	RXS12DVJU	
	FTXS15DVJU	RXS15DVJU	
	FTXS18DVJU	RXS18DVJU	
	FTXS24DVJU	RXS24DVJU	
The Slim Duct Built-in System	FDXS09DVJU	RXS09DVJU	
	FDXS12DVJU	RXS12DVJU	

Note: Power Supply Intake ; Outdoor Unit

2. Functions

Category	Functions	FTXS09-12DVJU FXS09-12DVJU	FTXS15-18-24DVJU FXS15-18-24DVJU	Category	Functions	FTXS09-12DVJU FXS09-12DVJU	FTXS15-18-24DVJU FXS15-18-24DVJU	
Basic Function	Inverter (with Inverter Power Control)	○	○	Health & Clean	Air Purifying Filter with Bacteriostatic, Virustatic Functions	—	—	
	Operation Limit for Cooling (°FDB)	14~115	14~115		Photocatalytic Deodorizing Filter	—	—	
	Operation Limit for Heating (°FWB)	5~64	5~64		Air Purifying Filter with Photocatalytic Deodorizing Function	○	○	
	PAM Control	○	○		Titanium Apatite Photocatalytic Air-Purifying Filter	—	—	
Compressor	Oval Scroll Compressor	—	—	Timer	Mold Proof Air Filter	○	○	
	Swing Compressor	○	○		Wipe-clean Flat Panel	○	○	
	Rotary Compressor	—	—		Washable Grille	—	—	
	Reluctance DC Motor	○	○		Filter Cleaning Indicator	—	—	
Comfortable Airflow	Power-Airflow Flap	—	—	Worry Free "Reliability & Durability"	Good-Sleep Cooling Operation	—	—	
	Power-Airflow Dual Flaps	○	○		24-Hour On/Off Timer	○	○	
	Power-Airflow Diffuser	—	—	Flexibility	Night Set Mode	○	○	
	Wide-Angle Louvers	○	○		Auto-Restart (after Power Failure)	○	○	
	Vertical Auto-Swing (Up and Down)	○	○	Self-Diagnosis (Digital, LED) Display	○	★		
	Horizontal Auto-Swing (Right and Left)	—	○	Wiring Error Check	—	—		
	3-D Airflow	—	○	Anticorrosion Treatment of Outdoor Heat Exchanger	○	○		
	Comfort Airflow Mode	—	—	Remote Control	Multi-Split / Split Type Compatible Indoor Unit	—	—	
3-Step Airflow (H/P Only)	—	—	Flexible Voltage Correspondence		—	—		
Comfort Control	Auto Fan Speed	○	○		High Ceiling Application	—	—	
	Indoor Unit Silent Operation	○	○		Chargeless	33ft	33ft	
	Night Quiet Mode (Automatic)	—	—		Either Side Drain (Right or Left)	○	○	
	Outdoor Unit Silent Operation (Manual)	○	○		Power Selection	—	—	
	Intelligent Eye	○	○		Remote Controller	5-Rooms Centralized Controller (Option)	○	○
	Quick Warming Function	○	○			Remote Control Adapter (Normal Open-Pulse Contact) (Option)	○	○
	Hot-Start Function	○	○	Remote Control Adapter (Normal Open Contact) (Option)	○	○		
	Automatic Defrosting	○	○	DIII-NET Compatible (Adapter) (Option)	○	○		
Operation	Automatic Operation	○	○	Remote Controller	Wireless	○	○	
	Program Dry Function	○	○		Wired	—	—	
	Fan Only	○	○					
Lifestyle Convenience	New Powerful Operation (Non-Inverter)	—	—					
	Inverter Powerful Operation	○	○					
	Priority-Room Setting	—	—					
	Cooling / Heating Mode Lock	—	—					
	Home Leave Operation	○	○					
	Indoor Unit On/Off Switch	○	○					
	Signal Reception Indicator	○	○					
	Temperature Display	—	—					
Another Room Operation	—	—						

Note: ○ : Holding Functions
— : No Functions

★ : Digital Only

Category	Functions	FDXS09-12DVJU RXS09-12DVJU	Category	Functions	FDXS09-12DVJU RXS09-12DVJU	
Basic Function	Inverter (with Inverter Power Control)	○	Health & Clean	Air Purifying Filter with Bacteriostatic, Virustatic Functions	—	
	Operation Limit for Cooling (°FDB)	14~115		Photocatalytic Deodorizing Filter	—	
	Operation Limit for Heating (°FWB)	5~64		Air Purifying Filter with Photocatalytic Deodorizing Function	—	
	PAM Control	○		Titanium Apatite Photocatalytic Air-Purifying Filter	—	
Compressor	Oval Scroll Compressor	—		Mold Proof Air Filter	—	
	Swing Compressor	○		Wipe-clean Flat Panel	—	
	Rotary Compressor	—		Washable Grille	—	
	Reluctance DC Motor	○		Filter Cleaning Indicator	—	
Comfortable Airflow	Power-Airflow Flap	—		Timer	Good-Sleep Cooling Operation	—
	Power-Airflow Dual Flaps	—			24-Hour On/Off Timer	○
	Power-Airflow Diffuser	—			Night Set Mode	○
	Wide-Angle Louvers	—			Auto-Restart (after Power Failure)	○
	Vertical Auto-Swing (Up and Down)	—	Worry Free "Reliability & Durability"	Self-Diagnosis (Digital, LED) Display	○ ★	
	Horizontal Auto-Swing (Right and Left)	—		Wiring Error Check	—	
	3-D Airflow	—		Anticorrosion Treatment of Outdoor Heat Exchanger	○	
	Comfort Airflow Mode	—		Multi-Split / Split Type Compatible Indoor Unit	—	
3-Step Airflow (H/P Only)	—	Flexibility	Flexible Voltage Correspondence	—		
Comfort Control	Auto Fan Speed		○	High Ceiling Application	—	
	Indoor Unit Silent Operation		○	Chargeless	33ft	
	Night Quiet Mode (Automatic)		—	Either Side Drain (Right or Left)	—	
	Outdoor Unit Silent Operation (Manual)		○	Power Selection	—	
	Intelligent Eye		—	Remote Control	5-Rooms Centralized Controller (Option)	○
	Quick Warming Function		○		Remote Control Adapter (Normal Open-Pulse Contact) (Option)	○
	Hot-Start Function		○		Remote Control Adapter (Normal Open Contact) (Option)	○
	Automatic Defrosting	○	DIII-NET Compatible (Adapter) (Option)		○	
Operation	Automatic Operation	○	Remote Controller	Wireless	○	
	Program Dry Function	○		Wired	—	
	Fan Only	○				
Lifestyle Convenience	New Powerful Operation (Non-Inverter)	—				
	Inverter Powerful Operation	○				
	Priority-Room Setting	—				
	Cooling / Heating Mode Lock	—				
	Home Leave Operation	○				
	Indoor Unit On/Off Switch	○				
	Signal Reception Indicator	○				
	Temperature Display	—				
Another Room Operation	—					

Note: ○ : Holding Functions
— : No Functions

★ : Digital Only

3. Specifications

The Single Split Duct-Free System

60Hz 208-230V

Models	Indoor Units		FTXS09DVJU		FTXS12DVJU	
	Outdoor Units		RXS09DVJU		RXS12DVJU	
			Cooling	Heating	Cooling	Heating
Capacity Rated (Min.-Max.)	Btu/h		8,500 (4,400~8,500)	10,000 (4,400~10,000)	11,500 (4,800~11,500)	11,500 (4,800~11,500)
Moisture Removal	Pt/h		2.3	—	3.2	—
Running Current (Rated)	A		4.13	4.98	5.51	4.73
Power Consumption Rated (Min.-Max.)	W		770(300~770)	1,070(290~1,220)	1,236(300~1,290)	1,000(310~1,190)
Power Factor	%		76.9	89.9	93.9	88.2
EER (Rated)	Btu/h-W		11.0	—	9.3	—
COP (Rated)	W/W		—	2.74	—	3.37
Energy Efficiency	SEER		16.0	—	16.0	—
	HSPF		—	8.8	—	8.8
Piping Connections	Liquid	inch	φ 1/4		φ 1/4	
	Gas	inch	φ 3/8		φ 3/8	
	Drain	inch	φ 11/16		φ 11/16	
Heat Insulation			Both Liquid and Gas Pipes		Both Liquid and Gas Pipes	
Max. Interunit Piping Length	feet		65		65	
Max. Interunit Height Difference	feet		49		49	
Chargeless	feet		33		33	
Amount of Additional Charge of Refrigerant	oz/ft		0.22		0.22	
Indoor Units			FTXS09DVJU		FTXS12DVJU	
Front Panel Color			White		White	
Air Flow Rate	cfm (m ³ /min)	H	246(7.0)	253(7.2)	242(6.8)	286(8.1)
		M	197(5.6)	220(6.2)	195(5.5)	237(6.7)
		L	148(4.2)	187(5.3)	148(4.2)	187(5.3)
Fan	Type		Cross Flow Fan		Cross Flow Fan	
	Motor Output	W	18		18	
	Speed	Steps	5 Steps, Silent and Auto		5 Steps, Silent and Auto	
Air Direction Control			Right, Left, Horizontal and Downward		Right, Left, Horizontal and Downward	
Air Filter			Removable / Washable / Mildew Proof		Removable / Washable / Mildew Proof	
Running Current (Rated)	A		0.18		0.18	
Power Consumption (Rated)	W		40		40	
Power Factor	%		96.6		96.6	
Temperature Control			Microcomputer Control		Microcomputer Control	
Dimensions (HxWxD)	inch		10-3/4x30-7/8x7-11/16		10-3/4x30-7/8x7-11/16	
Packaged Dimensions (HxWxD)	inch		10-3/16x32-13/16x12-13/16		10-3/16x32-13/16x12-13/16	
Weight	Lbs		16.6		16.6	
Gross Weight	Lbs		25.0		25.0	
Operation Sound	H/M/L	dBA	38 / 32 / 25	38 / 33 / 28	40 / 33 / 26	39 / 34 / 29
Outdoor Units			RXS09DVJU		RXS12DVJU	
Casing Color			Ivory White		Ivory White	
Compressor	Type		Hermetically Sealed Swing Type		Hermetically Sealed Swing Type	
	Model		1YC23NXD#EA		1YC23NXD#EA	
	Motor Output	W	600		600	
Refrigerant Oil	Type		FVC50K		FVC50K	
	Charge	oz	12.6		12.6	
Refrigerant	Type		R-410A		R-410A	
	Charge	Lbs	1.76		2.2	
Air Flow Rate	cfm (m ³ /min)	H	1,120(31.7)	1,008(28.5)	1,031(29.2)	927(26.3)
		L	816(23.1)	813(23.0)	737(20.9)	737(20.9)
Fan	Type		Propeller		Propeller	
	Motor Output	W	31		31	
Running Current (Rated)	A		3.93	4.8	5.33	4.6
Power Consumption (Rated)	W		730	1,030	1,190	960
Power Factor	%		80.4	93.3	97.1	91.7
Starting Current	A		5.0		6.4	
Dimensions (HxWxD)	inch		21-5/8x30-1/8x11-1/4		21-5/8x30-1/8x11-1/4	
Packaged Dimensions (HxWxD)	inch		25x34-5/8x14-3/16		25x34-5/8x14-3/16	
Weight	Lbs		74.0		79.0	
Gross Weight	Lbs		84.0		91.0	
Operation Sound	H / L	dBA	48 / —	49 / —	49 / —	51 / —
Drawing No.			C: 3D047919		C: 3D047920	

Note: ■ The data are based on the conditions shown in the table below.

Cooling	Heating	Piping Length
Indoor ; 80°FDB/67°FWB Outdoor ; 95°FDB/75°FWB	Indoor ; 70°FDB/60°FWB Outdoor ; 47°FDB/43°FWB	25ft

Conversion Formulae
kcal/h=kWx860 Btu/h=kWx3414 cfm=m ³ /minx35.3

60Hz 208-230V

Model	Indoor Units		FTXS15DVJU		FTXS18DVJU	
	Outdoor Units		RXS15DVJU		RXS18DVJU	
			Cooling	Heating	Cooling	Heating
Capacity Rated (Min.-Max.)	Btu/h		15,000 (3,200-15,000)	18,000 (3,200-21,200)	18,000 (3,200-18,000)	21,600 (3,200-24,000)
Moisture Removal	Pt/h		3.4	—	4.3	—
Running Current (Rated)	A		5.44	6.88	6.97	8.71
Power Consumption Rated (Min.-Max.)	W		1,230(450-1,230)	1,570(450-2,540)	1,590(450-1,590)	2,000(450-2,620)
Power Factor	%		95.1	96.7	96.7	97.8
EER (Rated)	Btu/h-W		12.2	—	11.3	—
COP (Rated)	W/W		—	3.36	—	3.17
Energy Efficiency	SEER		17.0	—	16.3	—
	HSPF		—	10.1	—	9.1
Piping Connections	Liquid	inch	φ 1/4		φ 1/4	
	Gas	inch	φ 1/2		φ 1/2	
	Drain	inch	φ 11/16		φ 11/16	
Heat Insulation			Both Liquid and Gas Pipes		Both Liquid and Gas Pipes	
Max. Interunit Piping Length	feet		98.4		98.4	
Min. Interunit Piping Length	feet		4.9		4.9	
Max. Interunit Height Difference	feet		65.6		65.6	
Chargeless	feet		33		33	
Amount of Additional Charge of Refrigerant	oz/ft		0.22		0.22	
Indoor Unit			FTXS15DVJU		FTXS18DVJU	
Front Panel Color			White		White	
Air Flow Rate	cfm (m³/min)	H	519(14.7)	515(14.6)	549(15.5)	609(17.2)
		M	436(12.3)	459(13.0)	476(13.5)	529(15.0)
		L	353(10.0)	402(11.4)	402(11.4)	448(12.7)
Fan	Type		Cross Flow Fan		Cross Flow Fan	
	Motor Output	W	43		43	
	Speed	Steps	5 Steps, Silent and Auto		5 Steps, Silent and Auto	
Air Direction Control			Right, Left, Horizontal and Downward		Right, Left, Horizontal and Downward	
Air Filter			Removable / Washable / Mildew Proof		Removable / Washable / Mildew Proof	
Running Current (Rated)	A		0.18		0.18	
Power Consumption (Rated)	W		40		40	
Power Factor	%		96.6		96.6	
Temperature Control			Microcomputer Control		Microcomputer Control	
Dimensions (HxWxD)	inch		11-7/16x41-5/16x9-3/8		11-7/16x41-5/16x9-3/8	
Packaged Dimensions (HxWxD)	inch		13-1/4x45-3/16x14-7/16		13-1/4x45-3/16x14-7/16	
Weight	Lbs		26.5		26.5	
Gross Weight	Lbs		38.0		38.0	
Operation Sound	H/M/L	dBa	45 / 41 / 36	44 / 40 / 35	45 / 41 / 36	44 / 40 / 35
Outdoor Unit			RXS15DVJU		RXS18DVJU	
Casing Color			Ivory White		Ivory White	
Compressor	Type		Hermetically Sealed Swing Type		Hermetically Sealed Swing Type	
	Model		2YC32JXD#E		2YC32JXD#E	
	Motor Output	W	1,500		1,500	
Refrigerant Oil	Model		FVC50K		FVC50K	
	Charge	oz	21.8		21.8	
Refrigerant	Model		R-410A		R-410A	
	Charge	Lbs	3.75		3.75	
Air Flow Rate	cfm (m³/min)	H	1,603(45.4)	1,367(38.7)	1,603(45.4)	1,367(38.7)
		L	1,451(41.1)	1,367(38.7)	1,451(41.1)	1,367(38.7)
Fan	Type		Propeller		Propeller	
	Motor Output	W	53		53	
Running Current (Rated)	A		5.3	6.7	6.79	8.5
Power Consumption (Rated)	W		1,190	1,530	1,550	1,960
Power Factor	%		98.4	99.3	99.3	99.9
Starting Current	A		10.0		11.4	
Dimensions (HxWxD)	inch		28-15/16x32-1/2x11-13/16		28-15/16x32-1/2x11-13/16	
Packaged Dimensions (HxWxD)	inch		31-7/16x37-15/16x15-3/8		31-7/16x37-15/16x15-3/8	
Weight	Lbs		117.0		117.0	
Gross Weight	Lbs		133.0		133.0	
Operation Sound	H / L	dBa	51 / —	51 / —	51 / —	51 / —
Drawing No.			3D047921		3D047922	

Note: ■ The data are based on the conditions shown in the table below.

Cooling	Heating	Piping Length
Indoor ; 80°FDB/67°FWB Outdoor ; 95°FDB/75°FWB	Indoor ; 70°FDB/60°FWB Outdoor ; 47°FDB/43°FWB	25ft

Conversion Formulae
kcal/h=kWx860 Btu/h=kWx3414 cfm=m³/minx35.3

60Hz 208-230V

Model	Indoor Units		FTXS24DVJU	
	Outdoor Units		RXS24DVJU	
			Cooling	Heating
Capacity Rated (Min.-Max.)	Btu/h	22,000 (3,200-22,000)		24,000 (3,200-25,400)
Moisture Removal	Pt/h	6.3		—
Running Current (Rated)	A	10.3		11.3
Power Consumption Rated (Min.-Max.)	W	2,360(450-2,360)		2,590(450-3,320)
Power Factor	%	97.7		97.9
EER (Rated)	Btu/h-W	9.3		—
COP (Rated)	W/W	—		2.72
Energy Efficiency	SEER	15.0		—
	HSPF	—		8.2
Piping Connections	Liquid	inch	φ 1/4	
	Gas	inch	φ 5/8	
	Drain	inch	φ 11/16	
Heat Insulation	Both Liquid and Gas Pipes			
Max. Interunit Piping Length	feet	98.4		
Min. Interunit Piping Length	feet	4.9		
Max. Interunit Height Difference	feet	65.6		
Chargeless	feet	33		
Amount of Additional Charge of Refrigerant	oz/ft	0.22		
Indoor Unit		FTXS24DVJU		
Front Panel Color		White		
Air Flow Rate	cfm (m³/min)	H	536(15.2)	586(16.6)
		M	473(13.4)	532(15.1)
		L	409(11.6)	477(13.5)
Fan	Type	Cross Flow Fan		
	Motor Output	W	43	
	Speed	Steps	5 Steps, Silent and Auto	
Air Direction Control		Right, Left, Horizontal and Downward		
Air Filter		Removable / Washable / Mildew Proof		
Running Current (Rated)	A	0.20		
Power Consumption (Rated)	W	45		
Power Factor	%	97.8		
Temperature Control		Microcomputer Control		
Dimensions (HxWxD)	inch	11-7/16x41-5/16x9-3/8		
Packaged Dimensions (HxWxD)	inch	13-1/4x45-3/16x14-7/16		
Weight	Lbs	26.5		
Gross Weight	Lbs	38.0		
Operation Sound	H/M/L	dBA	46 / 42 / 37	46 / 42 / 37
Outdoor Unit		RXS24DVJU		
Casing Color		Ivory White		
Compressor	Type	Hermetically Sealed Swing Type		
	Model	2YC45EXD#E		
	Motor Output	W	1,900	
Refrigerant Oil	Model	FVC50K		
	Charge	oz	25.2	
Refrigerant	Model	R-410A		
	Charge	Lbs	3.75	
Air Flow Rate	cfm (m³/min)	H	1,752(49.6)	1,465(41.5)
		L	1,529(43.3)	1,398(39.6)
Fan	Type	Propeller		
	Motor Output	W	53	
Running Current (Rated)	A	10.1	11.1	
Power Consumption (Rated)	W	2,315	2,545	
Power Factor	%	99.7	99.7	
Starting Current	A	11.8		
Dimensions (HxWxD)	inch	28-15/16x32-1/2x11-13/16		
Packaged Dimensions (HxWxD)	inch	31-7/16x37-15/16x15-3/8		
Weight	Lbs	121.0		
Gross Weight	Lbs	137.0		
Operation Sound	H / L	dBA	54 / —	54 / —
Drawing No.	3D047923			

Note: ■ The data are based on the conditions shown in the table below.

Cooling	Heating	Piping Length
Indoor ; 80°FDB/67°FWB Outdoor ; 95°FDB/75°FWB	Indoor ; 70°FDB/60°FWB Outdoor ; 47°FDB/43°FWB	25ft

Conversion Formulae
kcal/h=kW×860 Btu/h=kW×3414 cfm=m³/min×35.3

The Slim Duct Built-in System

60Hz 208-230V

Models	Indoor Units		FDXS09DVJU		FDXS12DVJU	
	Outdoor Units		RXS09DVJU		RXS12DVJU	
			Cooling	Heating	Cooling	Heating
Capacity Rated (Min.-Max.)	Btu/h		8,500 (4,400~8,500)	10,000 (4,400~10,000)	11,500 (4,800~11,500)	11,500 (4,800~11,500)
Moisture Removal	Pt/h		2.5	—	4.0	—
Running Current (Rated)	A		4.2	4.5	5.9	4.6
Power Consumption Rated (Min.-Max.)	W		770(300~770)	950(290~1,220)	1,290(300~1,290)	960(290~1,190)
Power Factor	%		79.7	91.8	95.1	90.7
EER (Rated)	Btu/h-W		10.9	—	8.85	—
COP (Rated)	W/W		—	3.0	—	3.5
Energy Efficiency	SEER		13.0	—	13.0	—
	HSPF		—	7.7	—	7.7
Piping Connections	Liquid	inch	φ 1/4		φ 1/4	
	Gas	inch	φ 3/8		φ 3/8	
	Drain	inch	VP20 (O.D. φ 1-1/32, I.D. φ 25/32)		VP20 (O.D. φ 1-1/32, I.D. φ 25/32)	
Heat Insulation			Both Liquid and Gas Pipes		Both Liquid and Gas Pipes	
Max. Interunit Piping Length	feet		65		65	
Max. Interunit Height Difference	feet		49		49	
Chargeless	feet		33		33	
Amount of Additional Charge of Refrigerant	oz/ft		0.22		0.22	
Indoor Units			FDXS09DVJU		FDXS12DVJU	
External Static Pressure	Pa		30		30	
Air Flow Rate	cfm	H	305	305	305	305
		M	280	280	280	280
		L	260	260	260	260
Fan	Type		Sirocco Fan		Sirocco Fan	
	Motor Output	W	62		62	
	Speed	Steps	5 Steps, Silent, Auto		5 Steps, Silent, Auto	
Air Filter			Removable / Washable / Mildew Proof		Removable / Washable / Mildew Proof	
Running Current (Rated)	A		0.52		0.52	
Power Consumption (Rated)	W		72		72	
Power Factor	%		60.2		60.2	
Temperature Control			Microcomputer Control		Microcomputer Control	
Dimensions (HxWxD)	inch		7-7/8x27-9/16x24-7/16		7-7/8x27-9/16x24-7/16	
Packaged Dimensions (HxWxD)	inch		10-13/16x30-1/4x36-5/16		10-13/16x30-1/4x36-5/16	
Weight	Lbs		47		47	
Gross Weight	Lbs		64		64	
Operation Sound	H/M/L	dBA	35 / 33 / 31	35 / 33 / 31	35 / 33 / 31	35 / 33 / 31
Outdoor Units			RXS09DVJU		RXS12DVJU	
Casing Color			Ivory White		Ivory White	
Compressor	Type		Hermetically Sealed Swing Type		Hermetically Sealed Swing Type	
	Model		1YC23NXD#EA		1YC23NXD#EA	
Refrigerant Oil	Motor Output	W	600		600	
	Type		FVC50K		FVC50K	
Refrigerant	Charge	oz	12.6		12.6	
	Type		R-410A		R-410A	
Refrigerant	Charge	Lbs	1.76		2.2	
	Air Flow Rate	cfm (m³/min)	H	1,120(31.7)	1,008(28.5)	1,031(29.2)
L			816(23.1)	813(23.0)	737(20.9)	737(20.9)
Fan	Type		Propeller		Propeller	
	Motor Output	W	31		31	
Running Current (Rated)	A		3.7	4.1	5.4	4.1
Power Consumption (Rated)	W		698	888	1,218	888
Power Factor	%		82.0	94.2	98.1	94.2
Dimensions (HxWxD)	inch		21-5/8x30-1/8x11-1/4		21-5/8x30-1/8x11-1/4	
Packaged Dimensions (HxWxD)	inch		25x34-5/8x14-3/16		25x34-5/8x14-3/16	
Weight	Lbs		74.0		79.0	
Gross Weight	Lbs		84.0		91.0	
Operation Sound	H / L	dBA	48 / —	49 / —	49 / —	51 / —
Drawing No.			3D051781A		3D051782A	

Note: ■ The data are based on the conditions shown in the table below.

Cooling	Heating	Piping Length
Indoor ; 80°FDB/67°FWB Outdoor ; 95°FDB/75°FWB	Indoor ; 70°FDB/60°FWB Outdoor ; 47°FDB/43°FWB	25ft

Conversion Formulae
kcal/h=kWx860 Btu/h=kWx3414 cfm=m³/minx35.3

4. Dimensions

4.1 Indoor Units

4.1.1 The Single Split Duct-Free System

FTXS09/12DVJU

THE MARK (→) SHOWS PIPING DIRECTION

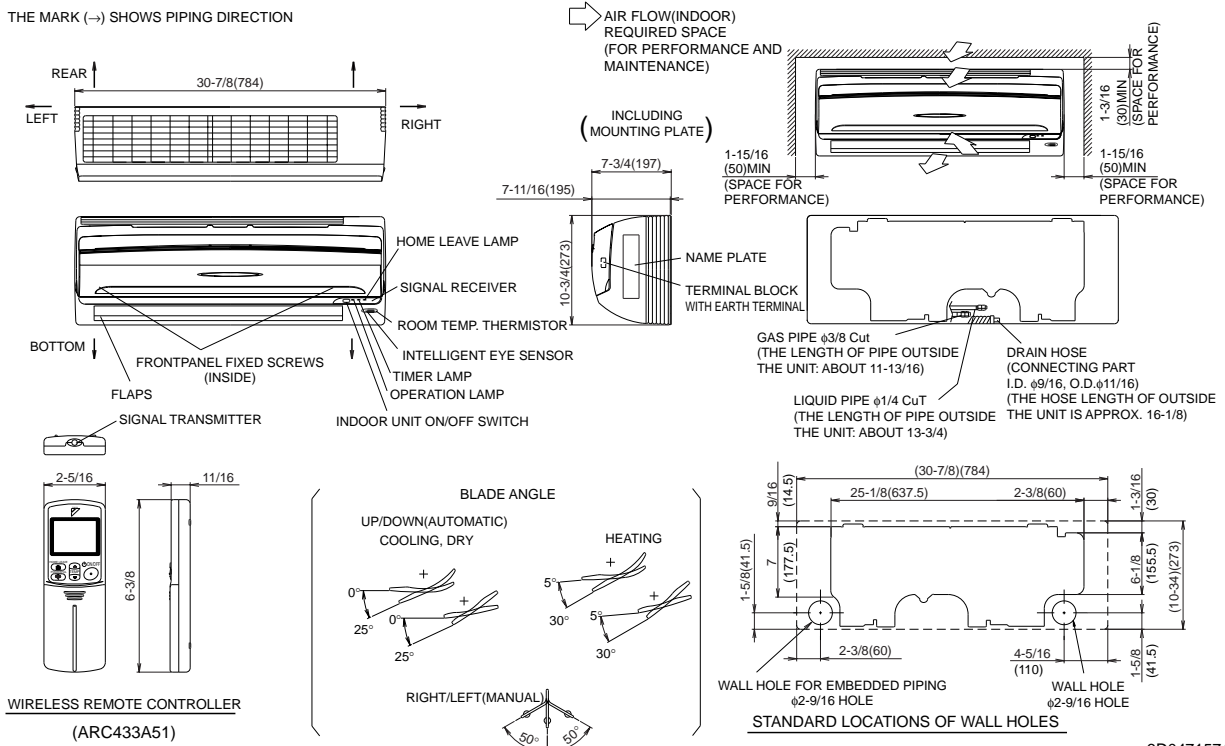

3D047157A

FTXS15/18DVJU

THE MARK (→) SHOWS PIPING DIRECTION

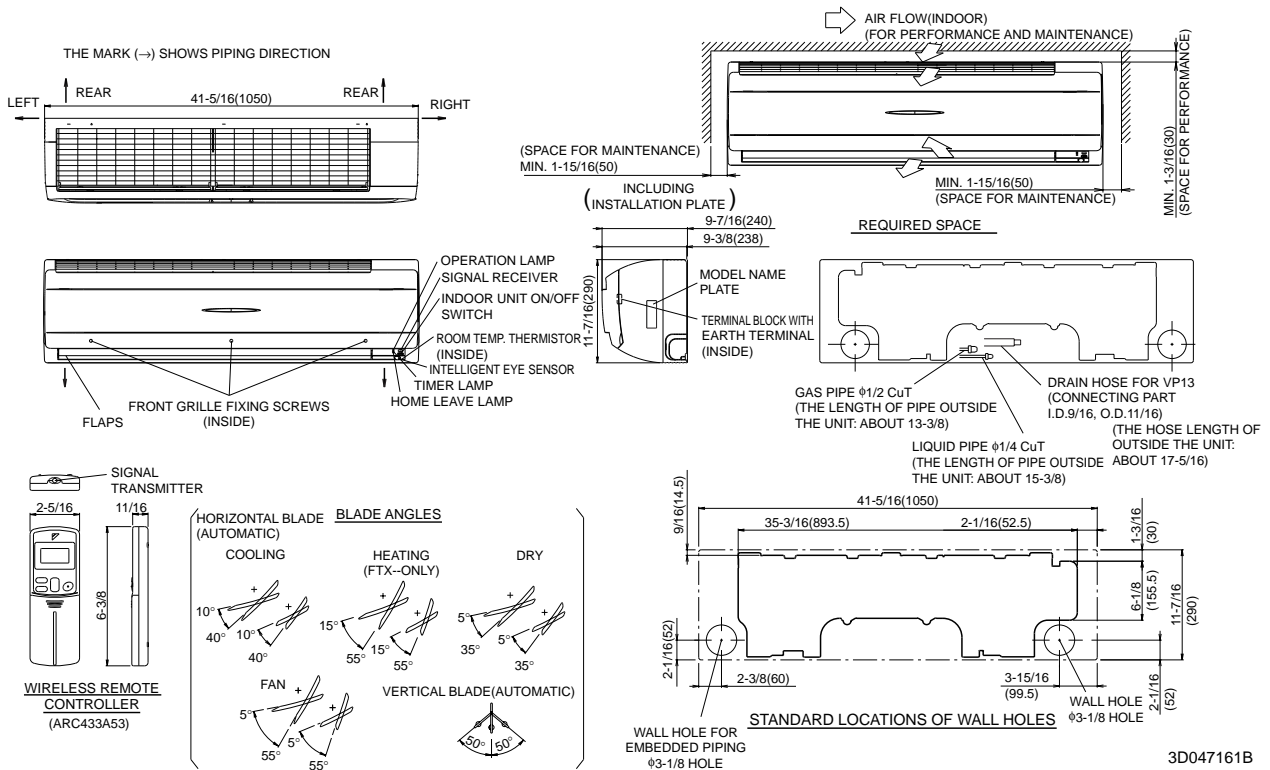

3D047161B

FTXS24DVJU

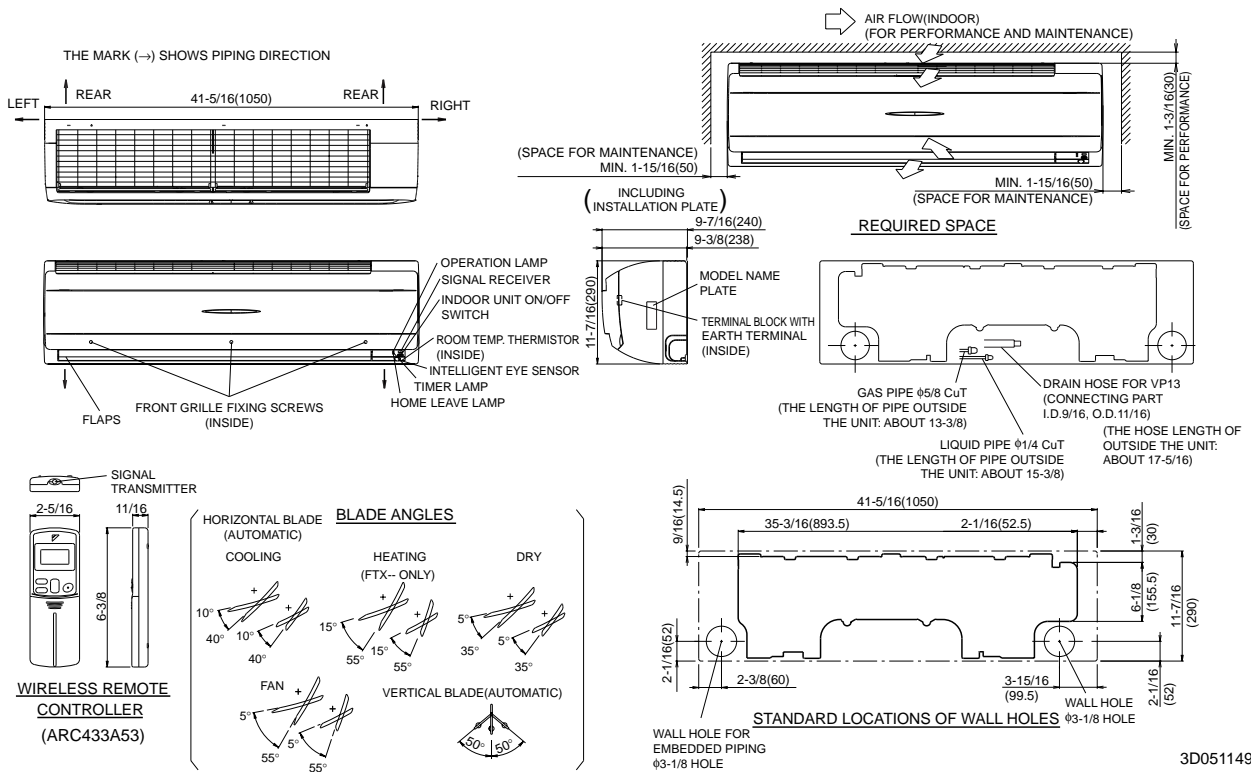

4.1.2 The Slim Duct Built-in System

FDXS09/12DVJU

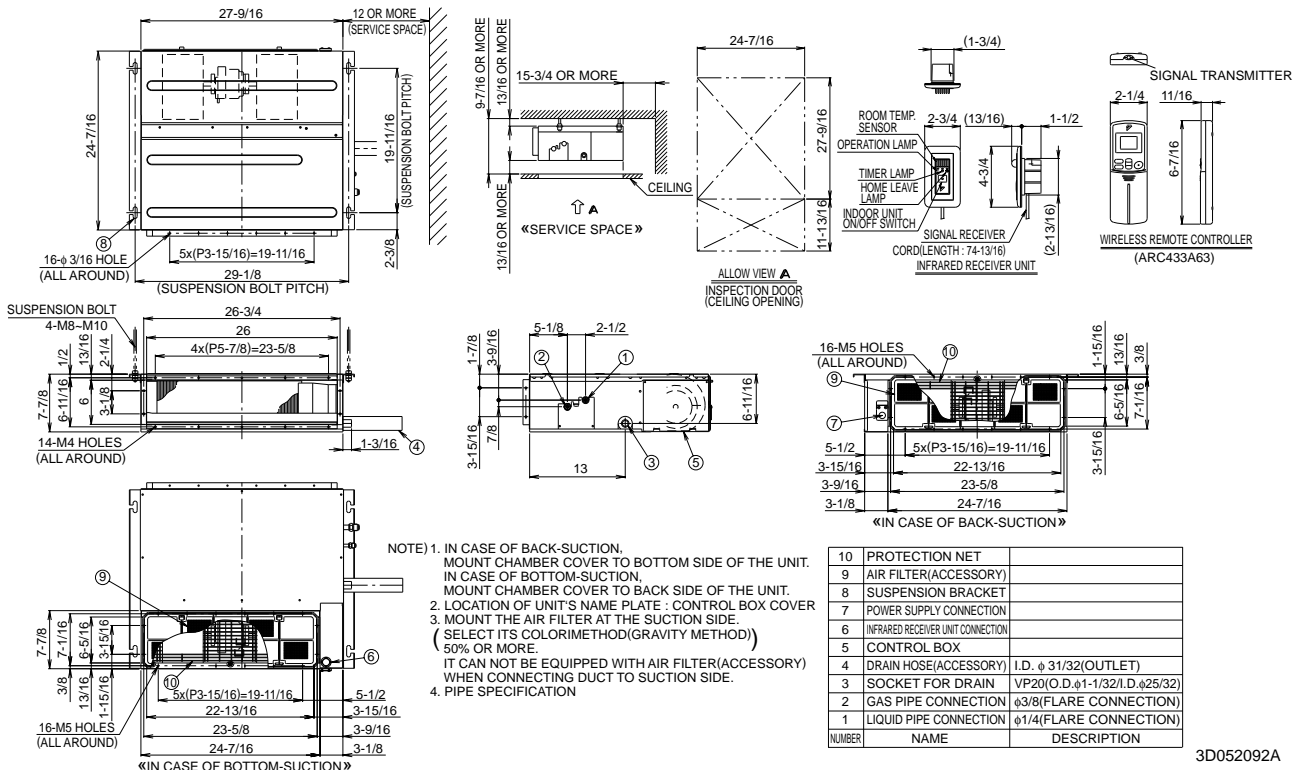

4.2 Outdoor Units

RXS09/12DVJU

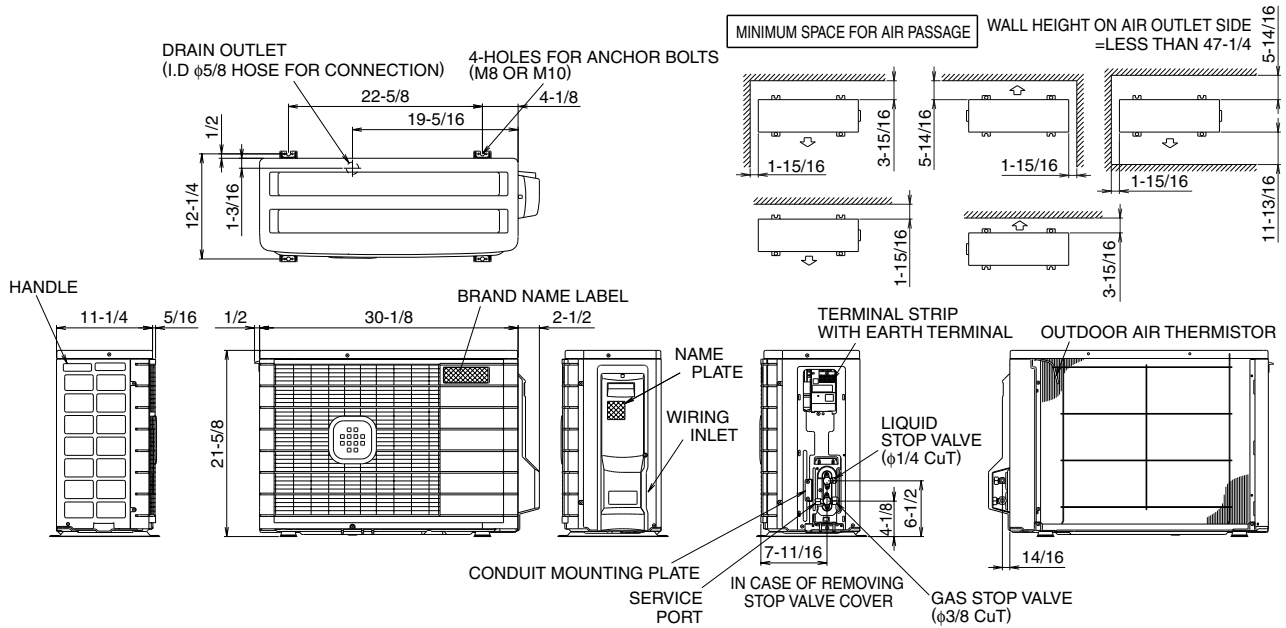

C : 3D047139

RXS15/18DVJU

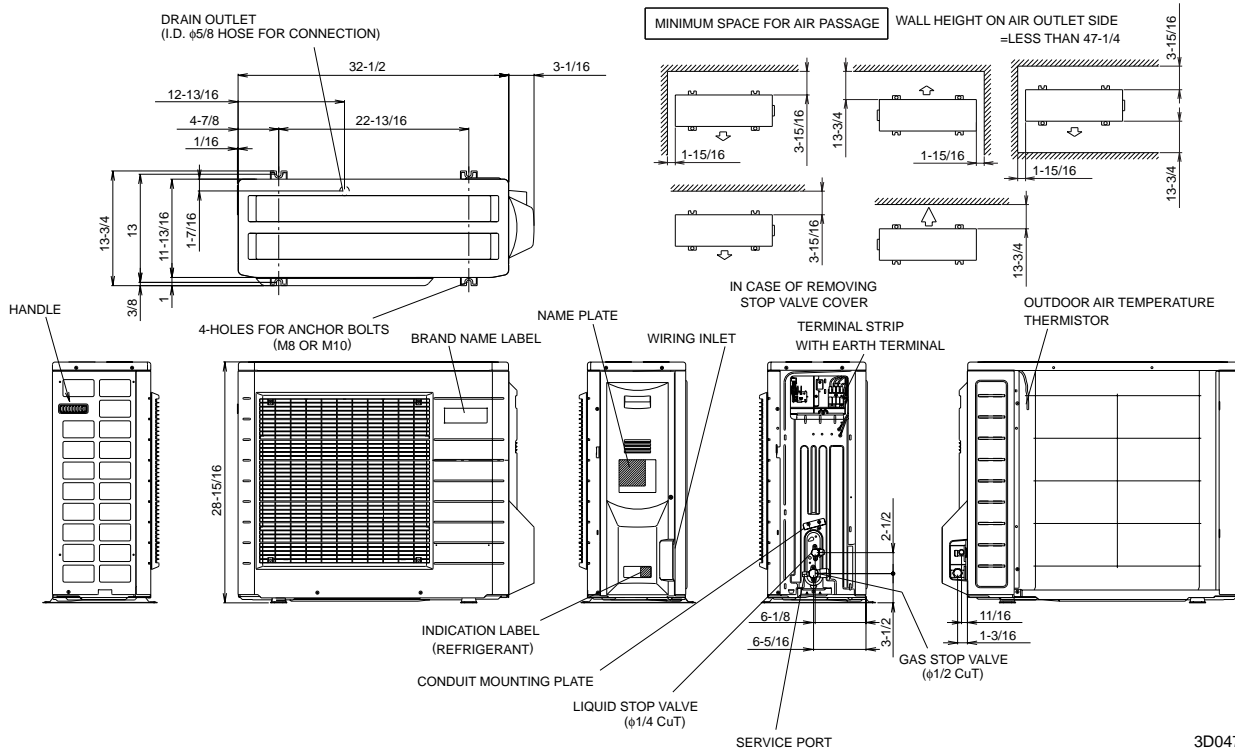

3D047140A

RXS24DVJU

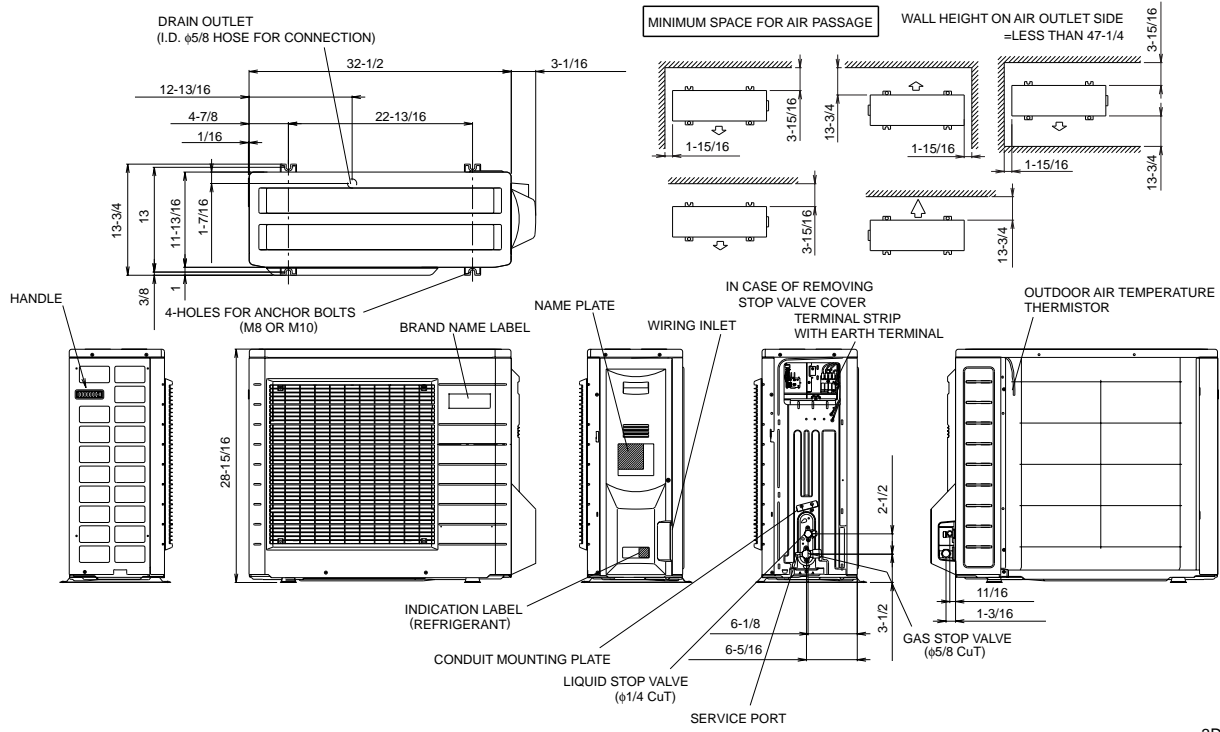

3D050689

5. Wiring Diagrams

5.1 Indoor Units

5.1.1 The Single Split Duct-Free System

FTXS09/12DVJU

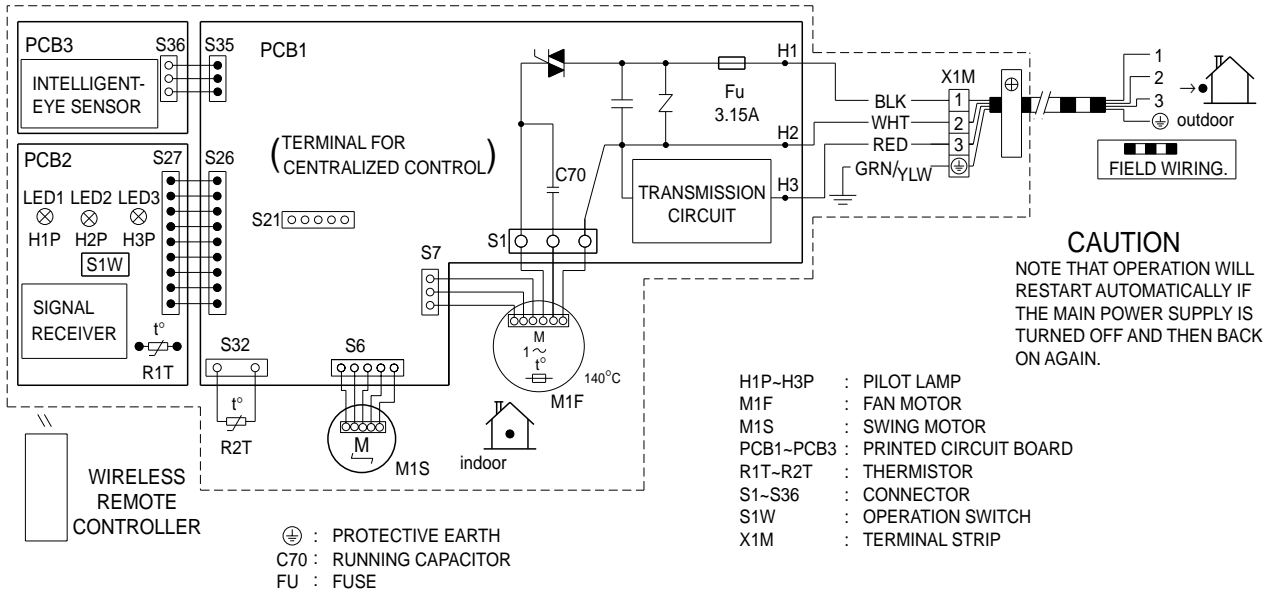

3D033599G

FTXS15/18/24DVJU

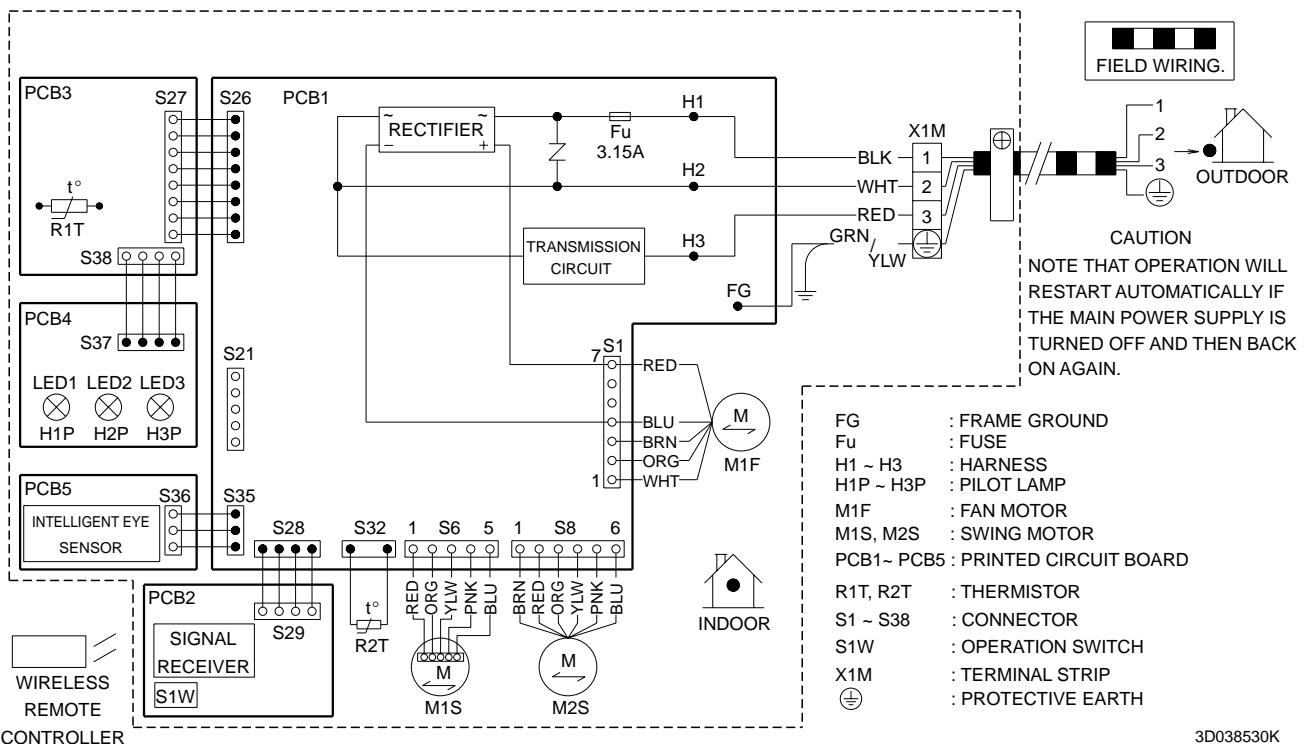

3D038530K

5.1.2 The Slim Duct Built-in System

FDXS09/12DVJU

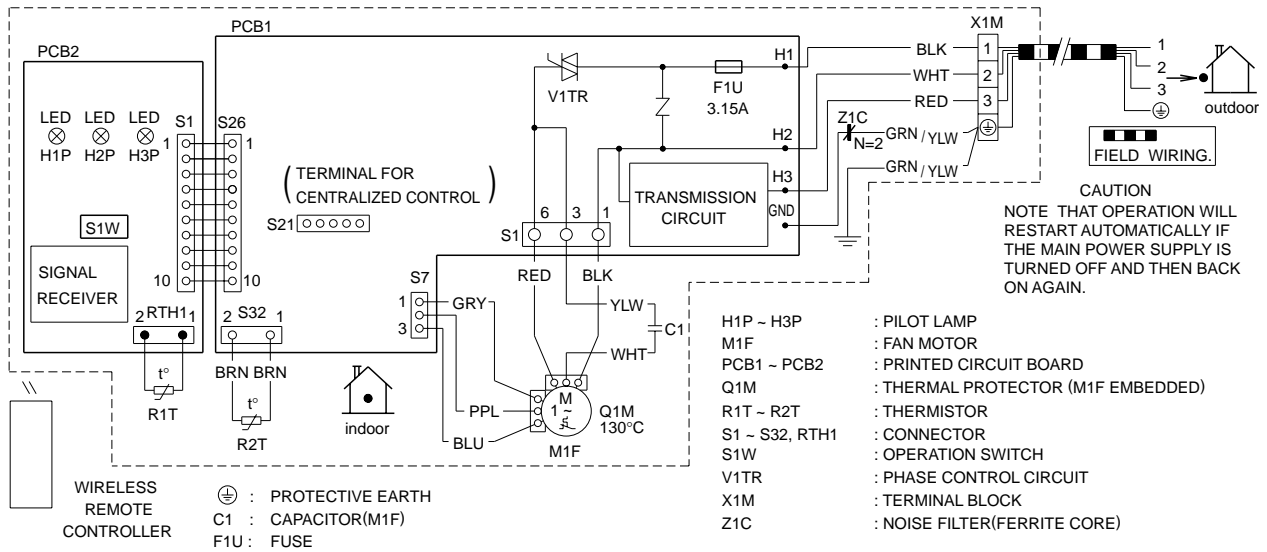

3D045012J

5.2 Outdoor Units

RXS09/12DVJU

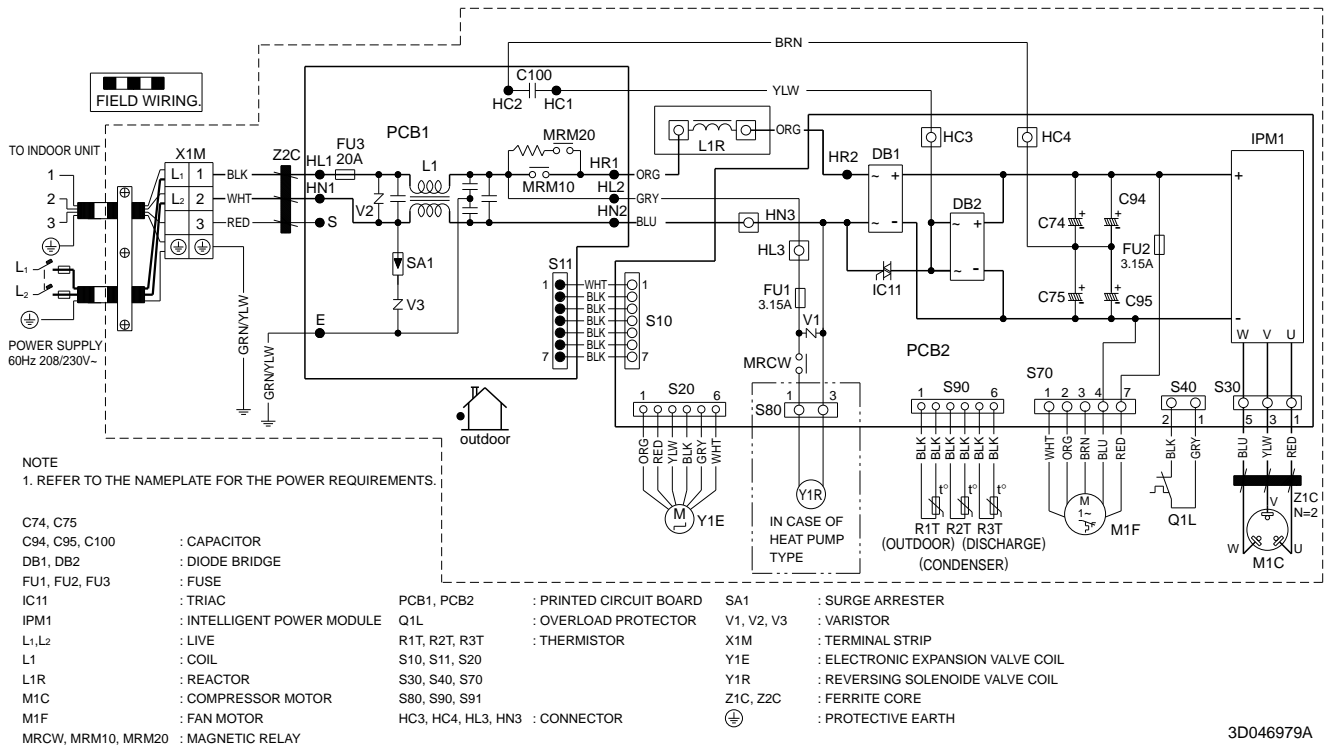

RXS15/18/24DVJU

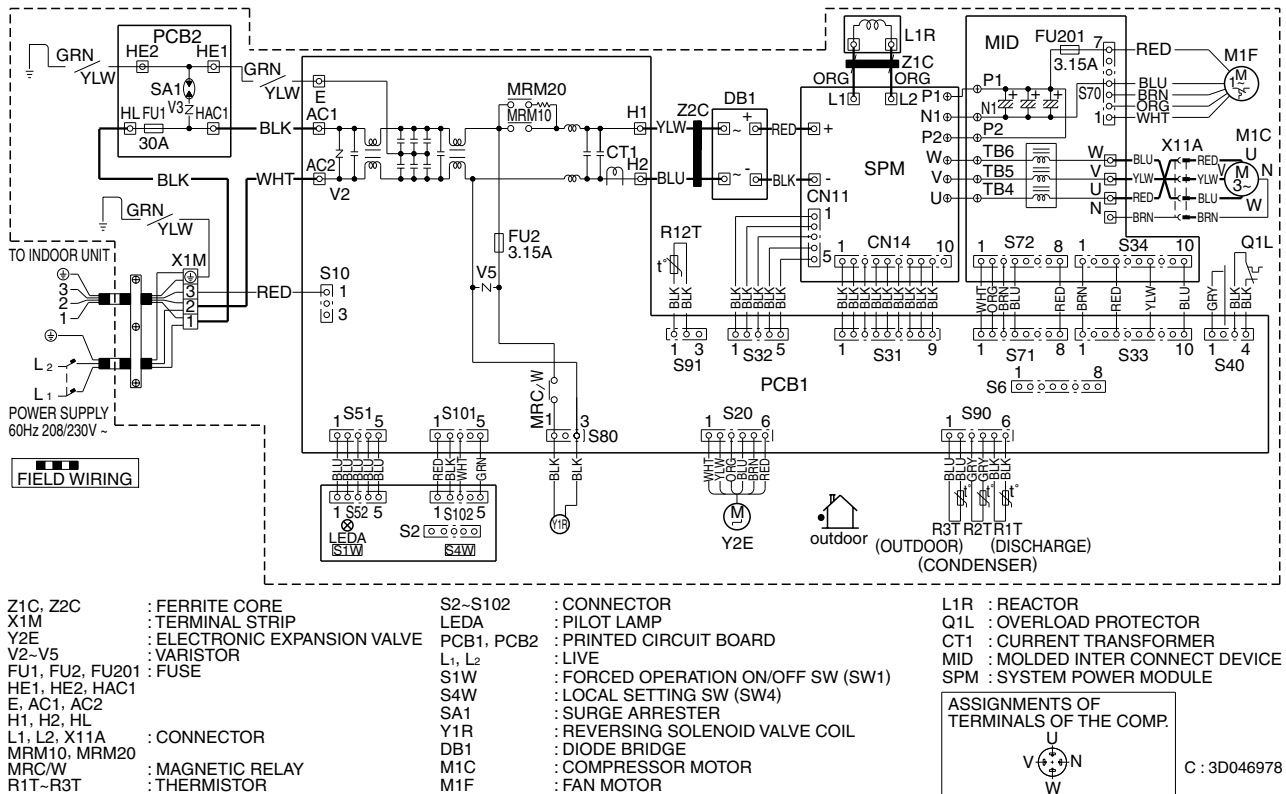

6. Piping Diagrams

6.1 Indoor Units

6.1.1 The Single Split Duct-Free System

FTXS09/12DVJU

FTXS15/18/24DVJU

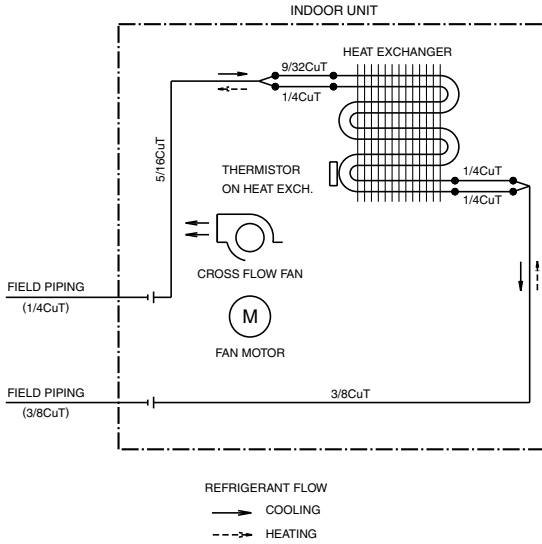

4D047158

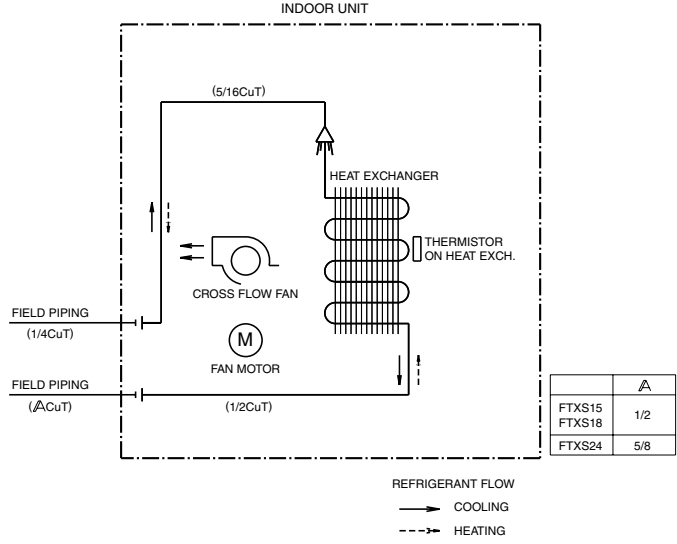

4D047162

6.1.2 The Slim Duct Built-in System

FDXS09/12DVJU

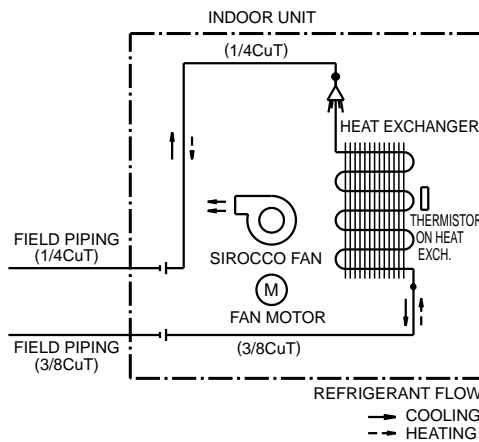

4D051787

6.2 Outdoor Units

RXS09DVJU

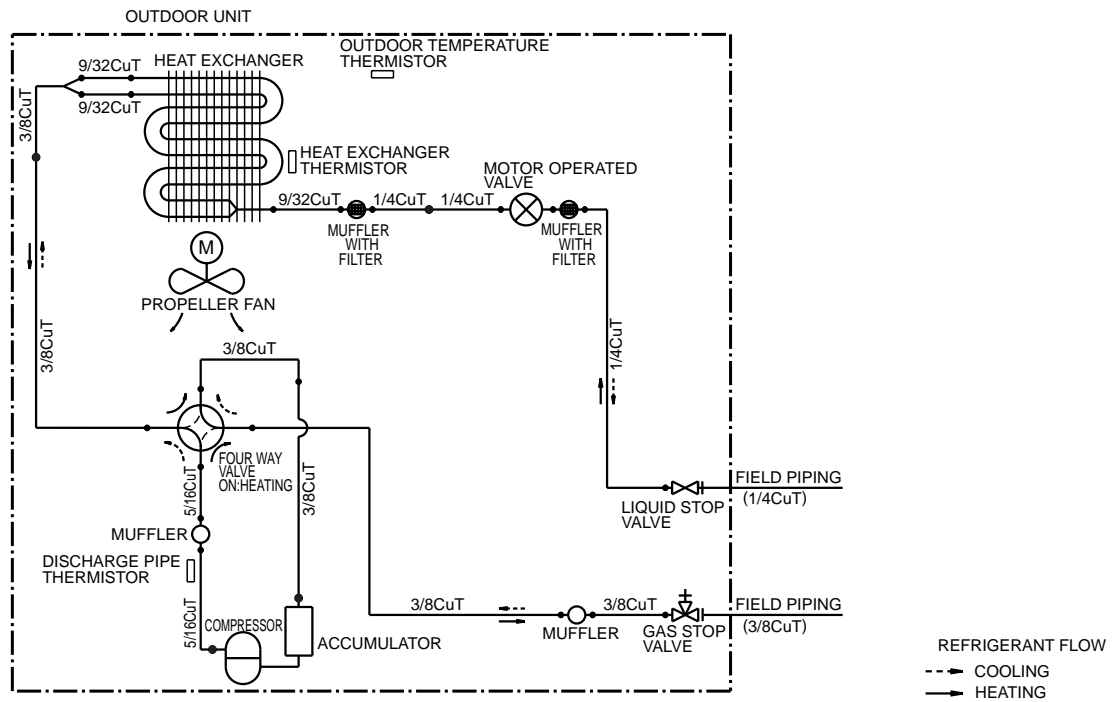

3D047143A

RXS12DVJU

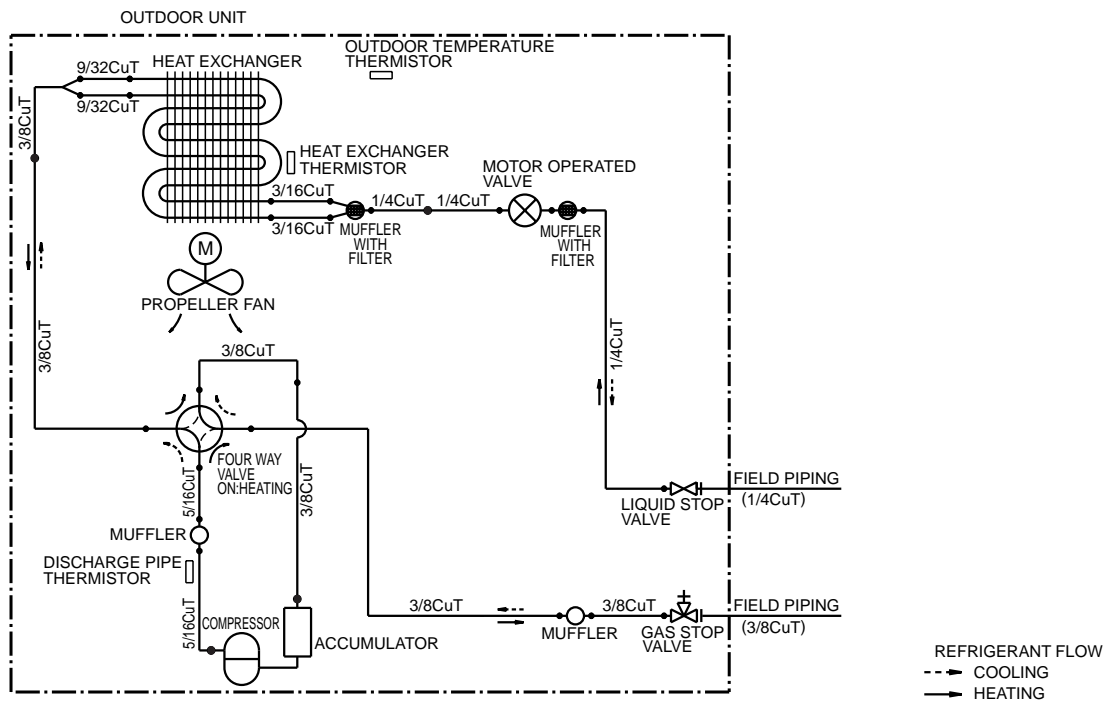

3D047142A

RXS15/18DVJU

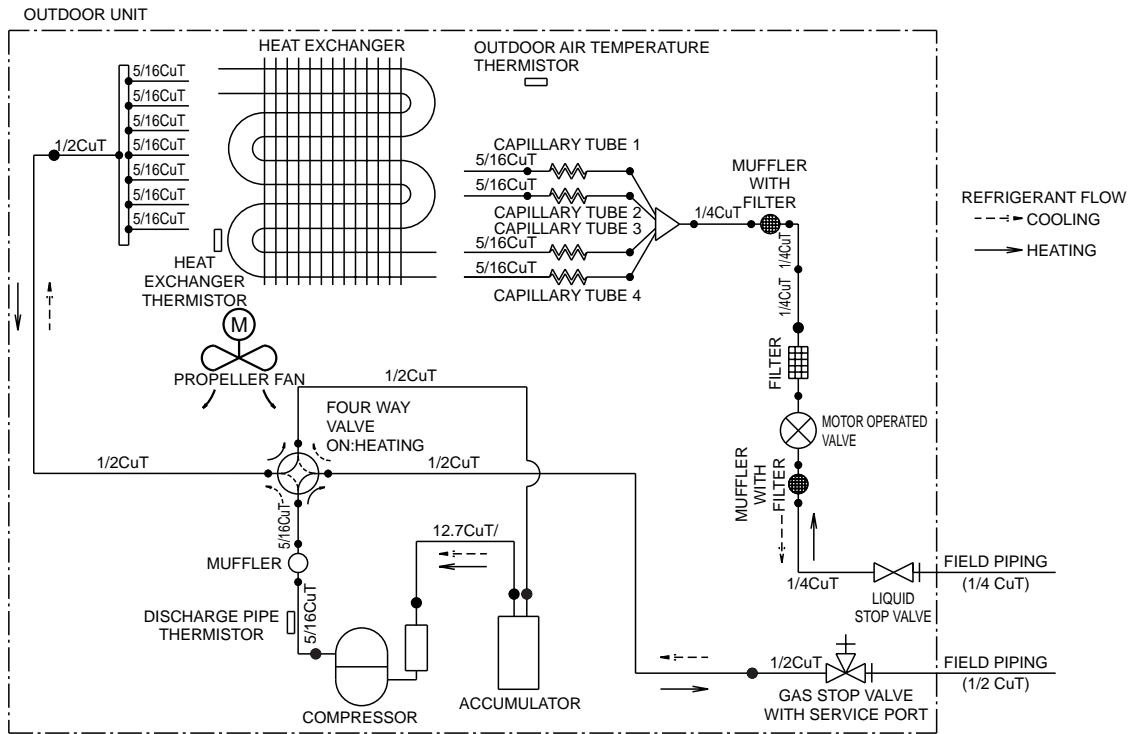

3D047141A

RXS24DVJU

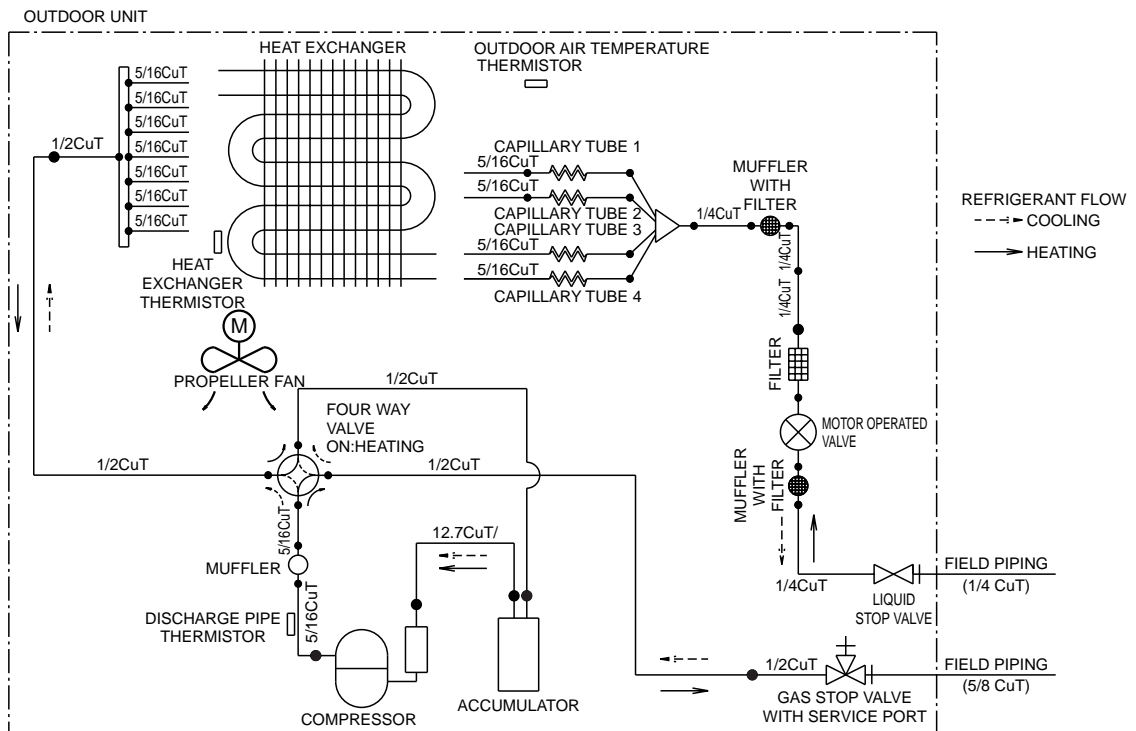

3D050325

7. Capacity Tables

7.1 The Single Split Duct-Free System

FTXS09DVJU + RXS09DVJU (208/230V, 60Hz)

Cooling

INDOOR		OUTDOOR TEMPERATURE(°FDB)											
EWB	EDB	68.0		77.0		86.0		89.6		95.0		104.0	
		°F	°F	TC	PI	TC	PI	TC	PI	TC	PI	TC	PI
57.2	68.0	8.67	0.63	8.27	0.68	7.88	0.73	7.72	0.75	7.48	0.78	7.08	0.84
60.8	71.6	9.13	0.63	8.73	0.68	8.33	0.73	8.18	0.75	7.94	0.78	7.54	0.83
64.4	77.0	9.52	0.62	9.13	0.67	8.73	0.72	8.57	0.75	8.33	0.78	7.93	0.83
67.0	80.0	9.72	0.62	9.32	0.67	8.92	0.72	8.77	0.74	8.50	0.77	8.13	0.83
71.6	86.0	10.31	0.62	9.91	0.67	9.51	0.72	9.35	0.74	9.12	0.77	8.72	0.82
75.2	89.6	10.70	0.61	10.30	0.66	9.91	0.71	9.75	0.73	9.51	0.76	9.11	0.81

Heating

INDOOR		OUTDOOR TEMPERATURE(°FWB)									
EDB	°F	14.0		23.0		32.0		43.0		50.0	
		TC	PI	TC	PI	TC	PI	TC	PI	TC	PI
60.8	6.20	0.92	7.51	0.96	8.83	1.00	10.40	1.05	11.45	1.08	
64.4	6.04	0.93	7.35	0.97	8.67	1.01	10.24	1.05	11.29	1.08	
68.0	5.88	0.94	7.19	0.98	8.51	1.02	10.08	1.06	11.13	1.09	
70.0	5.80	0.94	7.11	0.98	8.43	1.02	10.00	1.07	11.05	1.10	
71.6	5.72	0.95	7.03	0.99	8.34	1.02	9.92	1.07	10.97	1.10	
75.2	5.56	0.96	6.87	0.99	8.18	1.03	9.76	1.08	10.81	1.11	

Symbols

EWB	: Entering wet bulb temp.	(°F)
EDB	: Entering dry bulb temp.	(°F)
TC	: Total capacity	(kBtu/h)
PI	: Power input	(kW)

Note:

1. Ratings shown are net capacities which include a deduction for indoor fan motor heat.
2. ■ shows nominal (rated) capacities and power input.
3. TC and PI must be calculated by interpolation using the figures in the above tables. (Figures out of the tables should not be used for calculation.)
4. Capacities are based on the following conditions.
Corresponding refrigerant piping length : 25ft
Level difference : 0ft

3D047924

FTXS12DVJU + RXS12DVJU (208/230V, 60Hz)

Cooling

INDOOR		OUTDOOR TEMPERATURE(°FDB)											
EWB	EDB	68.0		77.0		86.0		89.6		95.0		104.0	
°F	°F	TC	PI	TC	PI	TC	PI	TC	PI	TC	PI	TC	PI
57.2	68.0	13.03	1.03	12.49	1.11	11.95	1.19	11.74	1.22	11.42	1.27	10.88	1.35
60.8	71.6	13.09	1.04	12.55	1.12	12.01	1.20	11.79	1.23	11.47	1.28	10.93	1.36
64.4	77.0	13.16	1.05	12.63	1.13	12.09	1.21	11.87	1.24	11.07	1.29	11.01	1.37
67.0	80.0	13.12	1.05	12.58	1.13	12.04	1.21	11.82	1.24	11.50	1.29	10.96	1.37
71.6	86.0	13.30	1.06	12.76	1.14	12.22	1.22	12.00	1.25	11.68	1.30	11.14	1.38
75.2	89.6	13.35	1.06	12.81	1.14	12.27	1.22	12.06	1.25	11.50	1.30	11.19	1.38

Heating

INDOOR		OUTDOOR TEMPERATURE(°FWB)									
EDB		14.0		23.0		32.0		43.0		50.0	
°F		TC	PI	TC	PI	TC	PI	TC	PI	TC	PI
60.8		6.65	0.82	8.19	0.87	9.73	0.92	11.58	0.97	12.82	1.01
64.4		6.61	0.83	8.15	0.88	9.70	0.93	11.55	0.98	12.78	1.02
68.0		6.58	0.84	8.12	0.89	9.66	0.94	11.52	0.99	12.75	1.03
70.0		6.56	0.85	8.10	0.89	9.65	0.94	11.50	1.00	12.73	1.04
71.6		6.54	0.85	8.09	0.90	9.63	0.95	11.48	1.00	12.71	1.04
75.2		6.51	0.86	8.05	0.91	9.59	0.96	11.45	1.01	12.68	1.05

Symbols

EWB	: Entering wet bulb temp.	(°F)
EDB	: Entering dry bulb temp.	(°F)
TC	: Total capacity	(kBtu/h)
PI	: Power input	(kW)

Note:

1. Ratings shown are net capacities which include a deduction for indoor fan motor heat.
2. ■ shows nominal (rated) capacities and power input.
3. TC and PI must be calculated by interpolation using the figures in the above tables. (Figures out of the tables should not be used for calculation.)
4. Capacities are based on the following conditions.
Corresponding refrigerant piping length : 25ft
Level difference : 0ft

3D047925

FTXS15DVJU + RXS15DVJU (208/230V, 60Hz)

Cooling

INDOOR		OUTDOOR TEMPERATURE(°FDB)											
EWB	EDB	68.0		77.0		86.0		89.6		95.0		104.0	
°F	°F	TC	PI	TC	PI	TC	PI	TC	PI	TC	PI	TC	PI
57.2	68.0	15.05	0.87	14.54	0.96	14.02	1.06	13.82	1.09	13.51	1.15	13.00	1.25
60.8	71.6	15.47	0.89	14.96	0.98	14.45	1.08	14.24	1.12	13.94	1.17	13.43	1.27
64.4	77.0	16.11	0.92	15.60	1.01	15.09	1.11	14.88	1.15	14.58	1.20	14.06	1.30
67.0	80.0	16.54	0.94	16.02	1.04	15.51	1.13	15.31	1.17	15.00	1.23	14.49	1.32
71.6	86.0	17.17	0.97	16.66	1.07	16.15	1.16	15.94	1.20	15.64	1.26	15.13	1.35
75.2	89.6	17.60	0.99	17.09	1.09	16.57	1.18	16.37	1.22	16.06	1.28	15.55	1.37

Heating

INDOOR		OUTDOOR TEMPERATURE(°FWB)									
EDB		14.0		23.0		32.0		43.0		50.0	
°F		TC	PI	TC	PI	TC	PI	TC	PI	TC	PI
60.8		8.42	1.06	11.32	1.16	14.22	1.26	17.70	1.38	20.02	1.46
64.4		8.54	1.14	11.44	1.24	14.34	1.34	17.82	1.46	20.14	1.54
68.0		8.66	1.21	11.56	1.31	14.46	1.41	17.94	1.53	20.26	1.61
70.0		8.72	1.25	11.62	1.35	14.52	1.45	18.00	1.57	20.32	1.65
71.6		8.78	1.29	11.68	1.39	14.58	1.49	18.06	1.61	20.38	1.69
75.2		8.90	1.36	11.80	1.46	14.70	1.56	18.18	1.68	20.50	1.77

Symbols

EWB	: Entering wet bulb temp.	(°F)
EDB	: Entering dry bulb temp.	(°F)
TC	: Total capacity	(kBtu/h)
PI	: Power input	(kW)

Note:

1. Ratings shown are net capacities which include a deduction for indoor fan motor heat.
2. ■ shows nominal (rated) capacities and power input.
3. TC and PI must be calculated by interpolation using the figures in the above tables. (Figures out of the tables should not be used for calculation.)
4. Capacities are based on the following conditions.
Corresponding refrigerant piping length : 25ft
Level difference : 0ft

3D047926

FTXS18DVJU + RXS18DVJU (208/230V, 60Hz)

Cooling

INDOOR		OUTDOOR TEMPERATURE(°FDB)											
EWB	EDB	68.0		77.0		86.0		89.6		95.0		104.0	
°F	°F	TC	PI	TC	PI	TC	PI	TC	PI	TC	PI	TC	PI
57.2	68.0	18.05	1.23	17.54	1.33	17.02	1.42	16.82	1.46	16.51	1.52	16.00	1.61
60.8	71.6	18.47	1.25	17.96	1.35	17.45	1.44	17.24	1.48	16.94	1.54	16.43	1.63
64.4	77.0	19.11	1.28	18.60	1.38	18.09	1.47	17.88	1.51	17.58	1.57	17.06	1.66
67.0	80.0	19.54	1.31	19.02	1.40	18.51	1.50	18.31	1.53	18.00	1.59	17.49	1.69
71.6	86.0	20.17	1.34	19.66	1.43	19.15	1.53	18.94	1.56	18.64	1.62	18.13	1.72
75.2	89.6	20.60	1.36	20.09	1.45	19.57	1.55	19.37	1.59	19.06	1.64	18.55	1.74

Heating

INDOOR		OUTDOOR TEMPERATURE(°FWB)									
EDB		14.0		23.0		32.0		43.0		50.0	
°F		TC	PI	TC	PI	TC	PI	TC	PI	TC	PI
60.8		12.02	1.49	14.92	1.59	17.82	1.69	21.30	1.81	23.62	1.89
64.4		12.14	1.57	15.04	1.67	17.94	1.77	21.42	1.89	23.74	1.97
68.0		12.26	1.64	15.16	1.74	18.06	1.84	21.54	1.96	23.86	2.04
70.0		12.32	1.68	15.22	1.78	18.12	1.88	21.60	2.00	23.92	2.08
71.6		12.38	1.72	15.28	1.82	18.18	1.92	21.66	2.04	23.98	2.12
75.2		12.50	1.79	15.40	1.89	18.30	1.99	21.78	2.11	24.10	2.20

Symbols

EWB	: Entering wet bulb temp.	(°F)
EDB	: Entering dry bulb temp.	(°F)
TC	: Total capacity	(kBtu/h)
PI	: Power input	(kW)

Note:

1. Ratings shown are net capacities which include a deduction for indoor fan motor heat.
2. ■ shows nominal (rated) capacities and power input.
3. TC and PI must be calculated by interpolation using the figures in the above tables. (Figures out of the tables should not be used for calculation.)
4. Capacities are based on the following conditions.
Corresponding refrigerant piping length : 25ft
Level difference : 0ft

3D047927

FTXS24DVJU + RXS24DVJU (208/230V, 60Hz)

Cooling

INDOOR		OUTDOOR TEMPERATURE(°FDB)											
EWB	EDB	68.0		77.0		86.0		89.6		95.0		104.0	
°F	°F	TC	PI	TC	PI	TC	PI	TC	PI	TC	PI	TC	PI
57.2	68.0	22.05	2.00	21.54	2.09	21.02	2.19	20.82	2.22	20.51	2.28	20.00	2.38
60.8	71.6	22.47	2.02	21.96	2.11	21.45	2.21	21.24	2.25	20.94	2.30	20.43	2.40
64.4	77.0	23.11	2.05	22.60	2.14	22.09	2.24	21.88	2.28	21.58	2.33	21.06	2.43
67.0	80.0	23.54	2.07	23.02	2.17	22.51	2.26	22.31	2.30	22.00	2.36	21.49	2.45
71.6	86.0	24.17	2.10	23.66	2.20	23.15	2.29	22.94	2.33	22.64	2.39	22.13	2.48
75.2	89.6	24.60	2.12	24.09	2.22	23.57	2.31	23.37	2.35	23.06	2.41	22.55	2.50

Heating

INDOOR		OUTDOOR TEMPERATURE(°FWB)									
EDB		14.0		23.0		32.0		43.0		50.0	
°F		TC	PI	TC	PI	TC	PI	TC	PI	TC	PI
60.8		14.42	2.08	17.32	2.18	20.22	2.28	23.70	2.40	26.02	2.48
64.4		14.54	2.16	17.44	2.26	20.34	2.36	23.82	2.48	26.14	2.56
68.0		14.66	2.23	17.56	2.33	20.46	2.43	23.94	2.55	26.26	2.63
70.0		14.72	2.27	17.62	2.37	20.52	2.47	24.00	2.59	26.32	2.67
71.6		14.78	2.31	17.68	2.41	20.58	2.51	24.06	2.63	26.38	2.71
75.2		14.90	2.38	17.80	2.48	20.70	2.58	24.18	2.70	26.50	2.79

Symbols

EWB	: Entering wet bulb temp.	(°F)
EDB	: Entering dry bulb temp.	(°F)
TC	: Total capacity	(kBtu/h)
PI	: Power input	(kW)

Note:

1. Ratings shown are net capacities which include a deduction for indoor fan motor heat.
2. ■ shows nominal (rated) capacities and power input.
3. TC and PI must be calculated by interpolation using the figures in the above tables. (Figures out of the tables should not be used for calculation.)
4. Capacities are based on the following conditions.
Corresponding refrigerant piping length : 25ft
Level difference : 0ft

3D047928

7.2 The Slim Duct Built-in System

FDXS09DVJU + RXS09DVJU (208/230V, 60Hz)

Cooling

INDOOR		OUTDOOR TEMPERATURE(°FDB)											
EWB	EDB	68.0		77.0		86.0		89.6		95.0		104.0	
		°F	°F	TC	PI	TC	PI	TC	PI	TC	PI	TC	PI
57.2	68.0	8.71	0.59	8.31	0.65	7.92	0.70	7.76	0.73	7.52	0.76	7.12	0.82
60.8	71.6	9.10	0.59	8.70	0.65	8.31	0.71	8.15	0.73	7.91	0.76	7.52	0.82
64.4	77.0	9.49	0.60	9.10	0.65	8.70	0.71	8.54	0.73	8.30	0.77	7.91	0.83
67.0	80.6	9.69	0.60	9.29	0.66	8.90	0.71	8.74	0.74	8.50	0.77	8.10	0.83
71.6	86.0	10.27	0.60	9.88	0.66	9.48	0.72	9.32	0.74	9.09	0.78	8.69	0.83
75.2	89.6	10.67	0.61	10.27	0.66	9.87	0.72	9.72	0.74	9.48	0.78	9.08	0.84

Heating

INDOOR		OUTDOOR TEMPERATURE(°FWB)									
EDB	°F	14.0		23.0		32.0		43.0		50.0	
		TC	PI	TC	PI	TC	PI	TC	PI	TC	PI
60.8	6.19	0.80	7.55	0.84	8.99	0.88	10.35	0.93	11.25	0.96	
64.4	5.88	0.81	7.22	0.85	8.85	0.89	10.21	0.94	11.11	0.97	
68.0	6.07	0.82	7.41	0.86	8.71	0.90	10.07	0.95	10.97	0.98	
70.0	5.94	0.82	7.28	0.86	8.65	0.90	10.00	0.95	10.90	0.98	
71.6	5.81	0.83	7.15	0.87	8.58	0.91	9.93	0.95	10.83	0.99	
75.2	5.69	0.84	7.02	0.88	8.44	0.92	9.79	0.96	10.70	0.99	

Symbols

EWB	: Entering wet bulb temp.	(°F)
EDB	: Entering dry bulb temp.	(°F)
TC	: Total capacity	(kBtu/h)
PI	: Power input	(kW)

Note:

1. Ratings shown are net capacities which include a deduction for indoor fan motor heat.
2. ■ shows nominal (rated) capacities and power input.
3. TC and PI must be calculated by interpolation using the figures in the above tables. (Figures out of the tables should not be used for calculation.)
4. Capacities are based on the following conditions.
Corresponding refrigerant piping length : 25ft
Level difference : 0ft

3D052897

FDXS12DVJU + RXS12DVJU (208/230V, 60Hz)

Cooling

INDOOR		OUTDOOR TEMPERATURE(°FDB)											
EWB	EDB	68.0		77.0		86.0		89.6		95.0		104.0	
°F	°F	TC	PI	TC	PI	TC	PI	TC	PI	TC	PI	TC	PI
57.2	68.0	11.78	0.99	11.24	1.09	10.71	1.18	10.50	1.22	10.17	1.28	9.64	1.37
60.8	71.6	12.31	1.00	11.77	1.09	11.24	1.19	11.03	1.22	10.70	1.28	10.17	1.38
64.4	77.0	12.84	1.00	12.30	1.10	11.77	1.19	11.55	1.23	11.23	1.29	10.70	1.38
67.0	80.6	13.10	1.00	12.57	1.10	12.03	1.19	11.82	1.23	11.50	1.29	10.96	1.39
71.6	86.0	13.90	1.01	13.36	1.11	12.83	1.20	12.61	1.24	12.29	1.30	11.76	1.39
75.2	89.6	14.43	1.02	13.89	1.11	13.36	1.21	13.14	1.25	12.82	1.30	12.29	1.40

Heating

INDOOR		OUTDOOR TEMPERATURE(°FWB)									
EDB		14.0		23.0		32.0		43.0		50.0	
°F		TC	PI	TC	PI	TC	PI	TC	PI	TC	PI
60.8		7.12	0.81	8.68	0.85	10.34	0.89	11.90	0.94	12.93	0.97
64.4		6.76	0.82	8.30	0.86	10.18	0.90	11.74	0.95	12.78	0.98
68.0		6.98	0.83	8.52	0.87	10.02	0.91	11.58	0.96	12.62	0.99
70.0		6.83	0.83	8.37	0.87	9.94	0.91	11.50	0.96	12.54	0.99
71.6		6.68	0.84	8.22	0.88	9.86	0.92	11.42	0.96	12.46	1.00
75.2		6.54	0.85	8.07	0.89	9.70	0.93	11.26	0.97	12.30	1.00

Symbols

EWB	: Entering wet bulb temp.	(°F)
EDB	: Entering dry bulb temp.	(°F)
TC	: Total capacity	(kBtu/h)
PI	: Power input	(kW)

Note:

1. Ratings shown are net capacities which include a deduction for indoor fan motor heat.
2. ■ shows nominal (rated) capacities and power input.
3. TC and PI must be calculated by interpolation using the figures in the above tables. (Figures out of the tables should not be used for calculation.)
4. Capacities are based on the following conditions.
Corresponding refrigerant piping length : 25ft
Level difference : 0ft

3D052898

7.3 Capacity correction factor by the length of refrigerant piping (Reference)

The cooling and the heating capacity of the unit has to be corrected in accordance with the length of refrigerant piping. (The distance between the indoor unit and the outdoor unit)

<— line : cooling capacity>
 <--- line : heating capacity>

7.3.1 09/12 Class

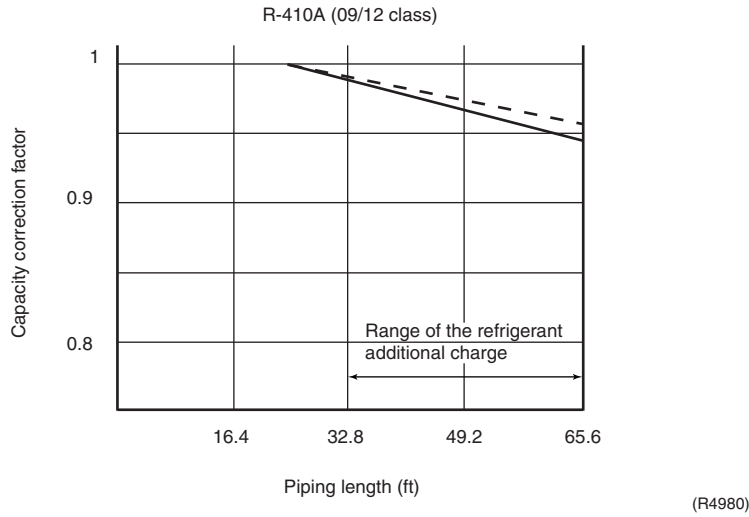

7.3.2 15/18/24 Class

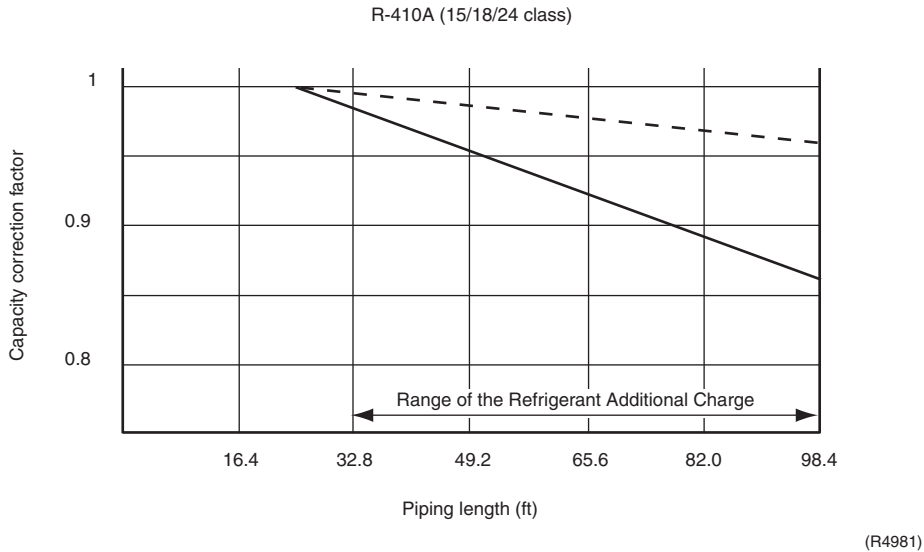

Note: The graphs show the factor when additional refrigerant of the proper quantity is charged.

8. Operation Limit

RXS09/12/15/18/24DVJU

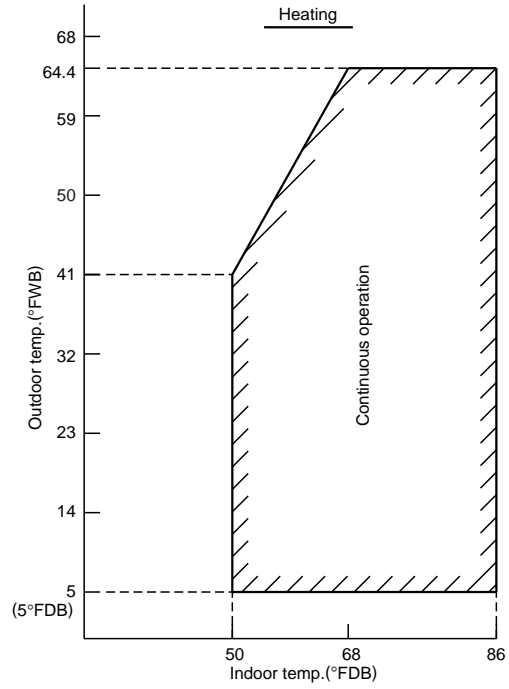
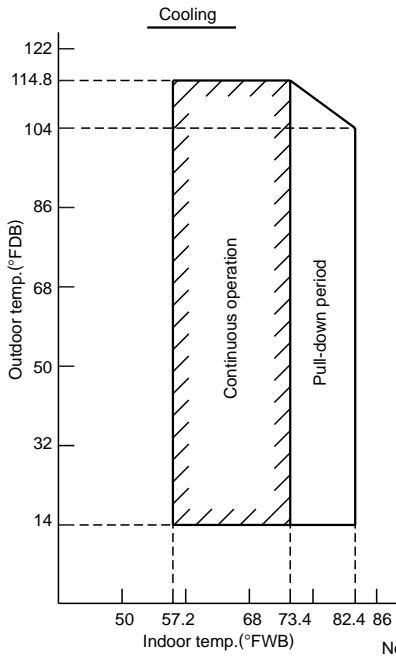

Notes:
The graphs are based on the following conditions.
• Equivalent piping length 25ft
• Level difference 0ft
• Air flow rate High

3D047649A

9. Fan Characteristics

FDXS09/12DVJU

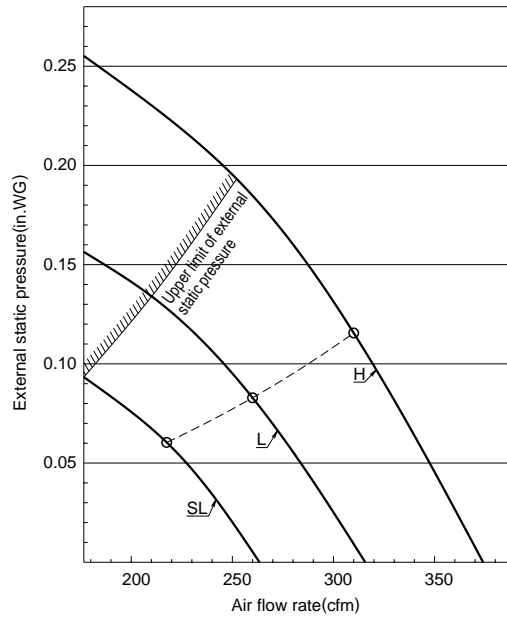

3D052855

10. Sound Level

10.1 Measuring Location

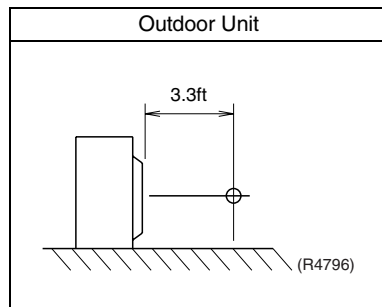
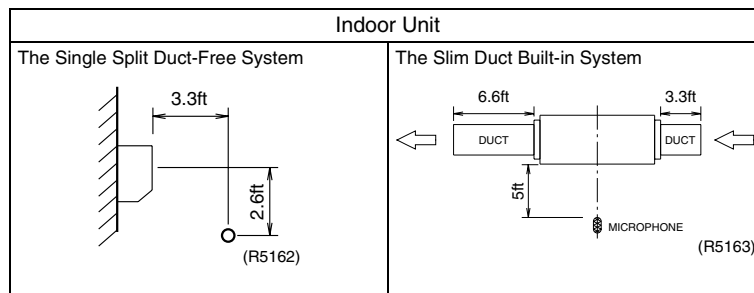

- Note:**
1. Operation sound is measured in an anechoic chamber.
 2. The data are based on the conditions shown in the table below.

Cooling	Heating	Piping Length
Indoor ; 80°FDB/67°FWB Outdoor ; 95°FDB/75°FWB	Indoor ; 70°FDB/60°FWB Outdoor ; 47°FDB/43°FWB	25ft

10.2 Octave Band Level

10.2.1 Indoor Units

FTXS09DVJU

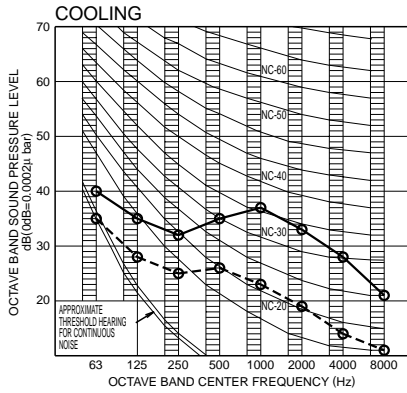

OVER ALL (dB)		
SCALE	60Hz 208/230v (H)	60Hz 208/230v (L)
A	38	25

(B.G.N IS ALREADY RECTIFIED)

OPERATING CONDITIONS

POWER SOURCE 208/230V 60Hz

JIS STANDARD

STANDARD EXTERNAL STATIC PRESSURE

○—○ 60Hz 208/230V(H)
○- -○ 60Hz 208/230V(L)

Cooling

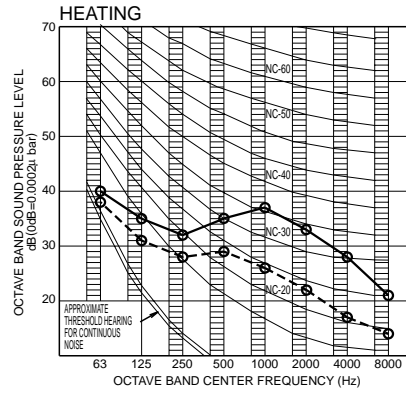

OVER ALL (dB)		
SCALE	60Hz 208/230v (H)	60Hz 208/230v (L)
A	38	28

(B.G.N IS ALREADY RECTIFIED)

OPERATING CONDITIONS

POWER SOURCE 208/230V 60Hz

JIS STANDARD

STANDARD EXTERNAL STATIC PRESSURE

○—○ 60Hz 208/230V(H)
○- -○ 60Hz 208/230V(L)

Heating

3D047160

FTXS12DVJU

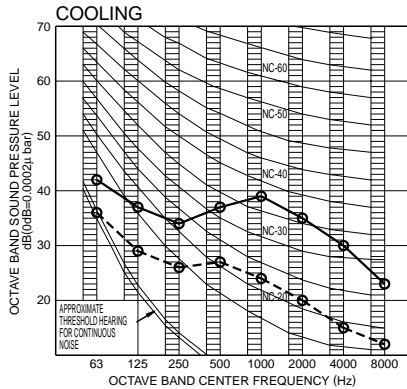

OVER ALL (dB)		
SCALE	60Hz 208/230v (H)	60Hz 208/230v (L)
A	40	26

(B.G.N IS ALREADY RECTIFIED)

OPERATING CONDITIONS

POWER SOURCE 208/230V 60Hz

JIS STANDARD

STANDARD EXTERNAL STATIC PRESSURE

○—○ 60Hz 208/230V(H)
○- -○ 60Hz 208/230V(L)

Cooling

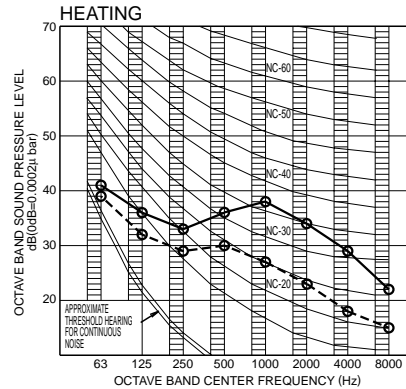

OVER ALL (dB)		
SCALE	60Hz 208/230v (H)	60Hz 208/230v (L)
A	39	29

(B.G.N IS ALREADY RECTIFIED)

OPERATING CONDITIONS

POWER SOURCE 208/230V 60Hz

JIS STANDARD

STANDARD EXTERNAL STATIC PRESSURE

○—○ 60Hz 208/230V(H)
○- -○ 60Hz 208/230V(L)

Heating

3D047170

FTXS15/18DVJU

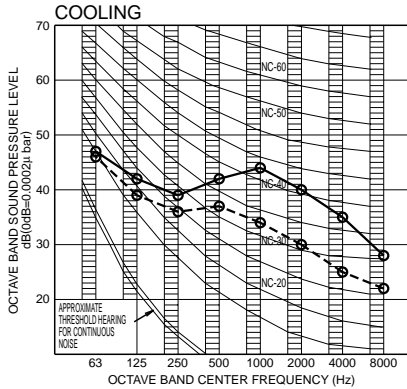

OVER ALL (dB)		
SCALE	60Hz 208/230v (H)	60Hz 208/230v (L)
A	45	36

(B.G.N IS ALREADY RECTIFIED)

OPERATING CONDITIONS

POWER SOURCE 208/230V 60Hz

JIS STANDARD

STANDARD EXTERNAL STATIC PRESSURE

○—○ 60Hz 208/230V(H)
○- -○ 60Hz 208/230V(L)

Cooling

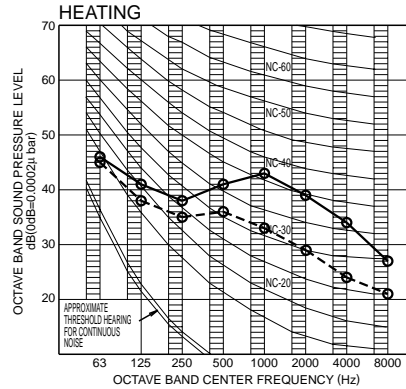

OVER ALL (dB)		
SCALE	60Hz 208/230v (H)	60Hz 208/230v (L)
A	44	35

(B.G.N IS ALREADY RECTIFIED)

OPERATING CONDITIONS

POWER SOURCE 208/230V 60Hz

JIS STANDARD

STANDARD EXTERNAL STATIC PRESSURE

○—○ 60Hz 208/230V(H)
○- -○ 60Hz 208/230V(L)

Heating

3D047167

FTXS24DVJU

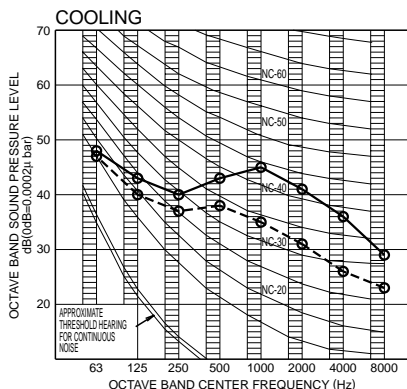

OVER ALL (dB)		
SCALE	60Hz 208/230v (H)	60Hz 208/230v (L)
A	46	37

(B.G.N IS ALREADY RECTIFIED)

OPERATING CONDITIONS

POWER SOURCE 208/230V 60Hz

JIS STANDARD

STANDARD EXTERNAL STATIC PRESSURE

○—○ 60Hz 208/230V(H)
○- -○ 60Hz 208/230V(L)

Cooling

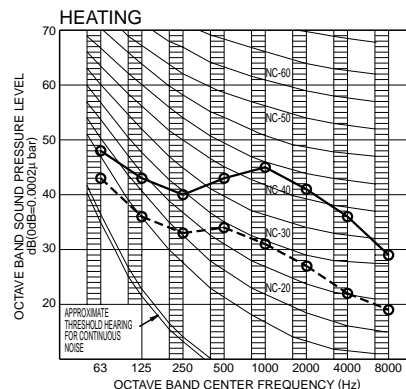

OVER ALL (dB)		
SCALE	60Hz 208/230v (H)	60Hz 208/230v (L)
A	46	37

(B.G.N IS ALREADY RECTIFIED)

OPERATING CONDITIONS

POWER SOURCE 208/230V 60Hz

JIS STANDARD

STANDARD EXTERNAL STATIC PRESSURE

○—○ 60Hz 208/230V(H)
○- -○ 60Hz 208/230V(L)

Heating

3D047171

FDXS09/12DVJU

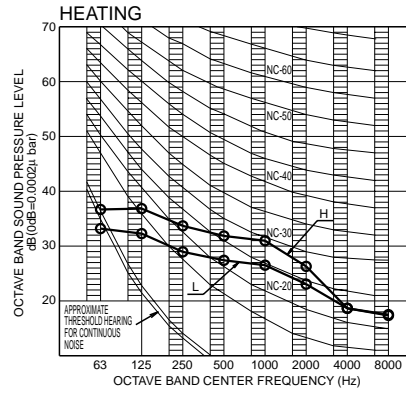
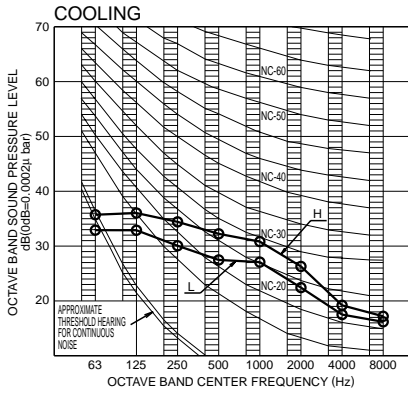

3D052856

10.2.2 Outdoor Units

RXS09DVJU

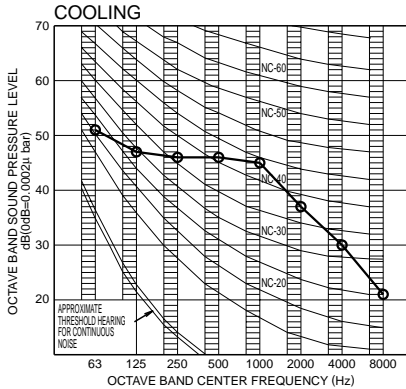

OVER ALL (dB)	
SCALE	60Hz 208/230v(H)
A	48
(B.G.N IS ALREADY RECTIFIED)	
OPERATING CONDITIONS	
POWER SOURCE	208/230V 60Hz
JIS STANDARD	
	60Hz 208/230V Cooling

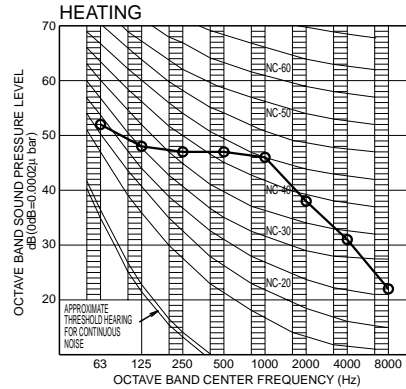

OVER ALL (dB)	
SCALE	60Hz 208/230v(H)
A	49
(B.G.N IS ALREADY RECTIFIED)	
OPERATING CONDITIONS	
POWER SOURCE	208/230V 60Hz
JIS STANDARD	
	60Hz 208/230V Heating

3D047644

RXS12DVJU

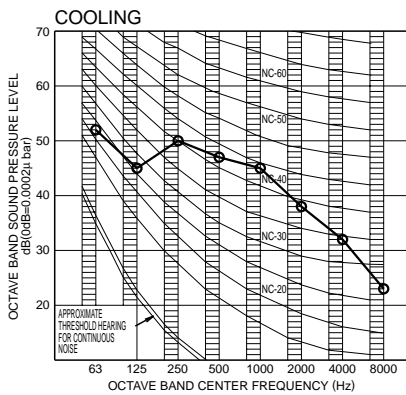

OVER ALL (dB)	
SCALE	60Hz 208/230v(H)
A	49
(B.G.N IS ALREADY RECTIFIED)	
OPERATING CONDITIONS	
POWER SOURCE	208/230V 60Hz
JIS STANDARD	
	60Hz 208/230V Cooling

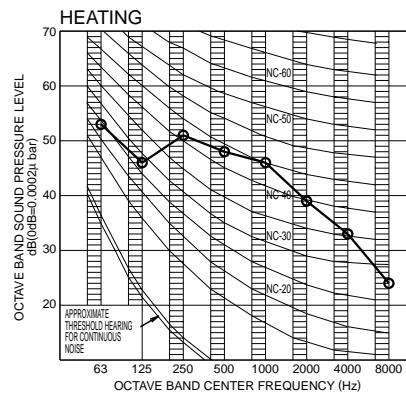

OVER ALL (dB)	
SCALE	60Hz 208/230v(H)
A	51
(B.G.N IS ALREADY RECTIFIED)	
OPERATING CONDITIONS	
POWER SOURCE	208/230V 60Hz
JIS STANDARD	
	60Hz 208/230V Heating

3D047645A

RXS15/18DVJU

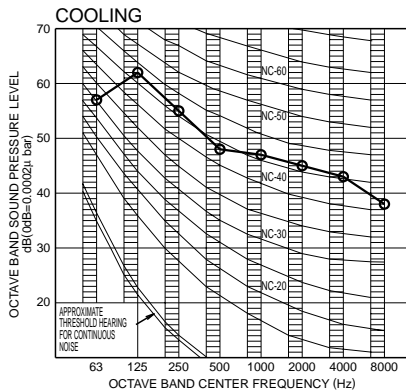

OVER ALL (dB)	
SCALE	60Hz 208/230v
A	51
(B.G.N IS ALREADY RECTIFIED)	
OPERATING CONDITIONS	
POWER SOURCE	208/230V 60Hz
JIS STANDARD	
	60Hz 208/230V Cooling

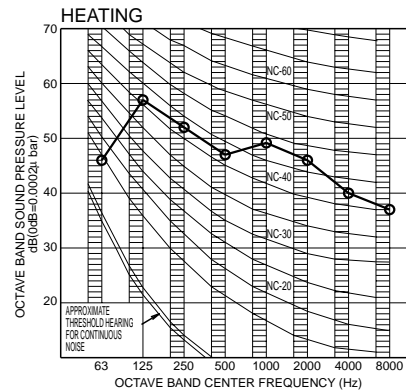

OVER ALL (dB)	
SCALE	60Hz 208/230v
A	51
(B.G.N IS ALREADY RECTIFIED)	
OPERATING CONDITIONS	
POWER SOURCE	208/230V 60Hz
JIS STANDARD	
	60Hz 208/230V Heating

3D047647

RXS24DVJU

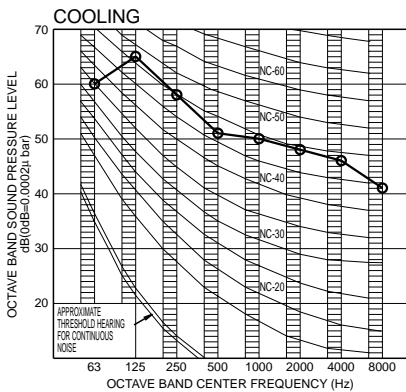

OVER ALL (dB)	
SCALE	60Hz 208/230v
A	54
(B.G.N IS ALREADY RECTIFIED)	
OPERATING CONDITIONS	
POWER SOURCE	208/230V 60Hz
JIS STANDARD	
	60Hz 208/230V Cooling

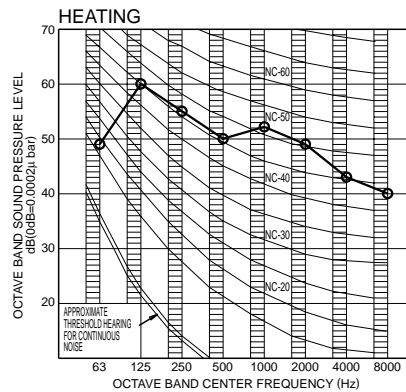

OVER ALL (dB)	
SCALE	60Hz 208/230v
A	54
(B.G.N IS ALREADY RECTIFIED)	
OPERATING CONDITIONS	
POWER SOURCE	208/230V 60Hz
JIS STANDARD	
	60Hz 208/230V Heating

3D047648A

11. Electric Characteristics

Representative Unit Combination		Power Supply				COMP		OFM		IFM	
Indoor Unit	Outdoor Unit	Hz-Volts	Voltage Range	MCA	MFA	RHz	RLA	W	FLA	W	FLA
FTXS09DVJU	RXS09DVJU	60-208	MAX. 60Hz 253V MIN. 60Hz 187V	6.1	15	73	5.1	31	0.2	18	0.2
		60-230					4.6				0.18
FTXS12DVJU	RXS12DVJU	60-208	MAX. 60Hz 253V MIN. 60Hz 187V	7.9	15	98	6.7	31	0.2	18	0.2
		60-230					6.0				0.18
FTXS15DVJU	RXS15DVJU	60-208	MAX. 60Hz 253V MIN. 60Hz 187V	13.7	20	108	11.8	53	0.24	43	0.2
		60-230					10.7				0.18
FTXS18DVJU	RXS18DVJU	60-208	MAX. 60Hz 253V MIN. 60Hz 187V	14.1	20	108	12.2	53	0.24	43	0.2
		60-230					11.0				0.18
FTXS24DVJU	RXS24DVJU	60-208	MAX. 60Hz 253V MIN. 60Hz 187V	15.8	20	100	13.6	53	0.26	43	0.22
		60-230					12.3				0.2
FDXS09DVJU	RXS09DVJU	60-208	MAX. 60Hz 253V MIN. 60Hz 187V	6.5	15	73	5.1	31	0.2	62	0.57
		60-230					4.6				0.52
FDXS12DVJU	RXS12DVJU	60-208	MAX. 60Hz 253V MIN. 60Hz 187V	8.3	15	98	6.7	31	0.2	62	0.57
		60-230					6.0				0.52

Symbols:

MCA : MIN. CIRCUIT AMPS (A)
 MFA : MAX. FUSE AMPS (A)
 RLA : RATED LOAD AMPS (A)
 OFM : OUTDOOR FAN MOTOR
 IFM : INDOOR FAN MOTOR
 FLA : FULL LOAD AMPS (A)
 W : FAN MOTOR RATED OUTPUT (W)
 RHz : RATED OPERATING FREQUENCY (Hz)

Note:

1. RLA is based on the following conditions.
Indoor temp. 80°FDB/67°FWB
Outdoor temp. 95°FDB/75°FWB
2. Maximum allowable voltage variation between phases is 2%.
3. Select wire size based on the larger value of MCA.
4. Instead of fuse, use circuit breaker.
5. Be sure to install an earth leak detector. (One that can handle higher harmonics.)
(This unit uses an inverter, which means that it must be used an earth leak detector capable handling high harmonics in order to prevent malfunctioning of the earth leak detector itself.)

3D047629
3D052896

12. Installation Manual

12.1 Indoor Units

12.1.1 Safety Precautions

SAFETY PRECAUTIONS



- Read these Safety Precautions carefully to ensure correct installation.
- This manual classifies the precautions into DANGER, WARNING and CAUTION. Be sure to follow all the precautions below: they are all important for ensuring safety.

 **DANGER**.....Indicates an imminently hazardous situation which, if not avoided, will result in death or serious injury.

 **WARNING**.....Failure to follow any of **WARNING** is likely to result in such grave consequences as death or serious injury.

 **CAUTION** Failure to follow any of **CAUTION** may in some cases result in grave consequences.

- The following safety symbols are used throughout this manual:

 Be sure to observe this instruction.	 Be sure to establish an earth connection.	 Never attempt.
--	---	--



- After completing installation, test the unit to check for installation errors. Give the user adequate instructions concerning the use and cleaning of the unit according to the Operation Manual.

 DANGER
• Refrigerant gas is heavier than air and replaces oxygen. A massive leak could lead to oxygen depletion, especially in basements, and an asphyxiation hazard could occur leading to serious injury or death.
• If the refrigerant gas leaks during installation, ventilate the area immediately. Refrigerant gas may produce a toxic gas if it comes in contact with fire such as from a fan heater, stove or cooking device. Exposure to this gas could cause severe injury or death.
• After completing the installation work, check that the refrigerant gas does not leak. Refrigerant gas may produce a toxic gas if it comes in contact with fire such as from a fan heater, stove or cooking device. Exposure to this gas could cause severe injury or death.
• Do not ground units to water pipes, telephone wires or lightning rods because incomplete grounding could cause a severe shock hazard resulting in severe injury or death, and to gas pipes because a gas leak could result in an explosion which could lead to severe injury or death.
• Safely dispose of the packing materials. Packing materials, such as nails and other metal or wooden parts, may cause stabs or other injuries. Tear apart and throw away plastic packaging bags so that children will not play with them. Children playing with plastic bags face the danger of death by suffocation.
• Do not install unit in an area where flammable materials are present due to risk of explosion resulting in serious injury or death.
• Do not ground units to telephone wires or lightning rods because lightning strikes could cause a severe shock hazard resulting in severe injury or death, and to gas pipes because a gas leak could result in an explosion which could lead to severe injury or death.

 WARNING
• Installation should be left to the authorized dealer or another trained professional. Improper installation may cause water leakage, electrical shock, fire, or equipment damage.
• Install the air conditioner according to the instructions given in this manual. Incomplete installation may cause water leakage, electrical shock, fire or equipment damage.
• Be sure to use the supplied or exact specified installation parts. Use of other parts may cause the unit to come to lose, water leakage, electrical shock, fire or equipment damage.
• Install the air conditioner on a solid base that is level and can support the weight of the unit. An inadequate base or incomplete installation may cause injury or equipment damage in the event the unit falls off the base or comes loose.
• Electrical work should be carried out in accordance with the installation manual and the national, state and local electrical wiring codes. Insufficient capacity or incomplete electrical work may cause electrical shock, fire or equipment damage.
• Be sure to use a dedicated power circuit. Never use a power supply shared by another appliance. Follow all appropriate electrical codes.
• For wiring, use a wire or cable long enough to cover the entire distance with no splices if possible. Do not use an extension cord. Do not put other loads on the power supply. Use a only a separate dedicated power circuit. (Failure to do so may cause abnormal heat, electric shock, fire or equipment damage.)
• Use the specified types of wires for electrical connections between the indoor and outdoor units. Follow all state and local electrical codes. Firmly clamp the interconnecting wires so their terminals receive no external stresses. Incomplete connections or clamping may cause terminal overheating, fire or equipment damage.

SAFETY PRECAUTIONS

 WARNING
<ul style="list-style-type: none"> • After connecting all wiring be sure to shape the cables so that they do not put undue stress on the electrical covers, panels or terminals. Install covers over the wires. Incomplete cover installation may cause terminal overheating, electrical shock, fire or equipment damage.
<ul style="list-style-type: none"> • When installing or relocating the system, be sure to keep the refrigerant circuit free from all substances other than the specified refrigerant (R410A), such as air. (Any presence of air or other foreign substance in the refrigerant circuit causes an abnormal pressure rise which may result in rupture, resulting in injury.)
<ul style="list-style-type: none"> • During pump-down, stop the compressor before removing the refrigerant piping. If the compressor is still running and the shut-off valve is open during pump-down, air will be sucked in when the refrigerant piping is removed, causing abnormally high pressure which could lead to equipment damage or and personal injury.
<ul style="list-style-type: none"> • During installation, attach the refrigerant piping securely before running the compressor. If the compressor is not attached and the shut-off valve is open during pump-down, air will be sucked in when the compressor is run, causing abnormally high pressure which could lead to equipment damage and personal injury.
<ul style="list-style-type: none"> • Install a leak circuit breaker, as required. If a leak circuit breaker is not installed, electric shock may result.
<ul style="list-style-type: none"> • Be sure to install a ground fault circuit interrupter breaker. Failure to install a ground fault circuit interrupter breaker may result in electrically shocks or personal injury.

 CAUTION
<ul style="list-style-type: none"> • Establish drain piping according to the instructions of this manual. Inadequate piping may cause water damage.
<ul style="list-style-type: none"> • Note for installing the outdoor unit. (For heat pump model only.) In regions of the country where the outside temperature is at or below the freezing point, the drain may freeze. If so, it is recommended that an electric heater be installed in order to protect the drain from freezing.
<ul style="list-style-type: none"> • Tighten the flare nut according to the specified torque. A torque wrench should be used. If the flare nut is tightened too much, the flare nut may crack over time and cause refrigerant leakage.
<ul style="list-style-type: none"> • Do not touch the heat exchanger fins. Improper handling may result in injury. <div style="text-align: right;"></div>
<ul style="list-style-type: none"> • Be very careful about product transportation. Some products use PP bands for packaging. Do not use any PP bands for a means of transportation. It is dangerous.

12.1.2 The Single Split Duct-Free System FTXS09/12DVJU

Accessories					
(A) Mounting plate	1	(E) Remote controller holder	1	(K) Operation manual	1
(B) Mounting plate fixing screws M3/16" X 1"L	10	(F) Fixing screws for remote controller holder M1/8" X 13/16"L	2	(L) Installation manual	1
(C) Air-purifying filter with photocatalytic deodorizing function	2	(G) AAA dry-cell batteries	2		
(D) Wireless remote controller	1	(H) Indoor unit fixing screws M3/16" X 1/2"L	2		

Choosing a Site

- Before choosing the installation site, obtain user approval.

- Indoor unit**
 - The indoor unit should be sited in a place where:
 - the restrictions on installation specified in the indoor unit installation drawings are met,
 - both air intake and exhaust have clear paths met,
 - the unit is not in the path of direct sunlight,
 - the unit is away from the source of heat or steam,
 - there is no source of machine oil vapour (this may shorten indoor unit life),
 - cool air is circulated throughout the room,
 - the unit is away from electronic ignition type fluorescent lamps (inverter or rapid start type) as they may shorten the remote control range,
 - the unit is at least 3.5ft away from any television or radio set (unit may cause interference with the picture or sound).
- Wireless Remote Controller**
 - Turn on all the fluorescent lamps in the room, if any, and find the site where remote control signals are properly received by the indoor unit (within 23ft).

Installation Tips

- How to remove the front grille.**
 - Hold the grille by the tabs on the two sides and lift it until it stops with a click.
 - Supporting the front grille with one hand, release the lock by sliding down the knob with the other hand.
 - To remove the front grille, pull it toward yourself with both hands.
- How to attach the front grille.**
 - Set the 3 keys of the front grille into the slots and push them in all the way.
 - Supporting the front grille with one hand, fit the lock by sliding up the knob with the other hand.
 - Close the front grille slowly in this state. (Push the grille at the 3 points, two at both sides and in the middle.)
- How to remove the front panel.**
 - Open the front grille.
 - Remove the screws (2 pcs) on the front panel.
 - Pull the lower part of the front panel toward you, then remove the front panel completely. (There are 2 hooks on the upper part.)
If it is difficult to remove, open the front grille and raise the top grid, using a screwdriver, to unhook the hooks.
- How to attach the front panel.**
 - Attach the front panel to the front grille, and lock the upper hooks (2 points) securely.
 - Tighten the screws (2) on the front panel.
 - Close the front grille.
- How to set the different addresses.**
 - When two indoor units are installed in one room, the two wireless remote controllers can be set for different addresses.
- PCB in the indoor unit**
 - Remove the front panel.
 - Remove the sensor parts cover (2-screws), then remove the electric parts box (1-screw).
 - Slide the metallic cover to remove it. (4-claws on the electric parts box.)
 - Cut the jumper JA on PCB.
- Wireless remote controller**
 - Cut the jumper J4.

J4	Address
EXIST	1
CUT	2

ADDRESS	JA
	EXIST 1
	CUT 2

Indoor Unit Installation Drawings

- **How to attach the indoor unit.**
 Hook the claws of the bottom frame to the mounting plate.
 If the claws are difficult to hook, remove the front grille.
- **How to remove the indoor unit.**
 Push up the marked area (at the lower part of the front grille) to release the claws.
 If it is difficult to release, remove the front grille.

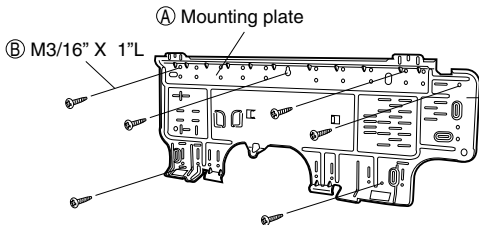
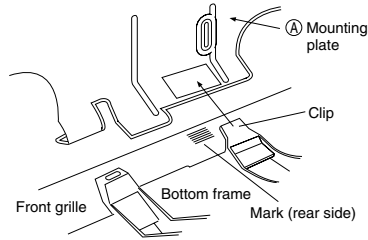

The mounting plate should be installed on a wall which can support the weight of the indoor unit.

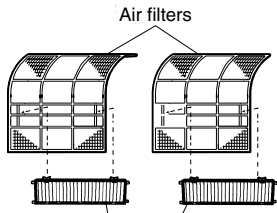
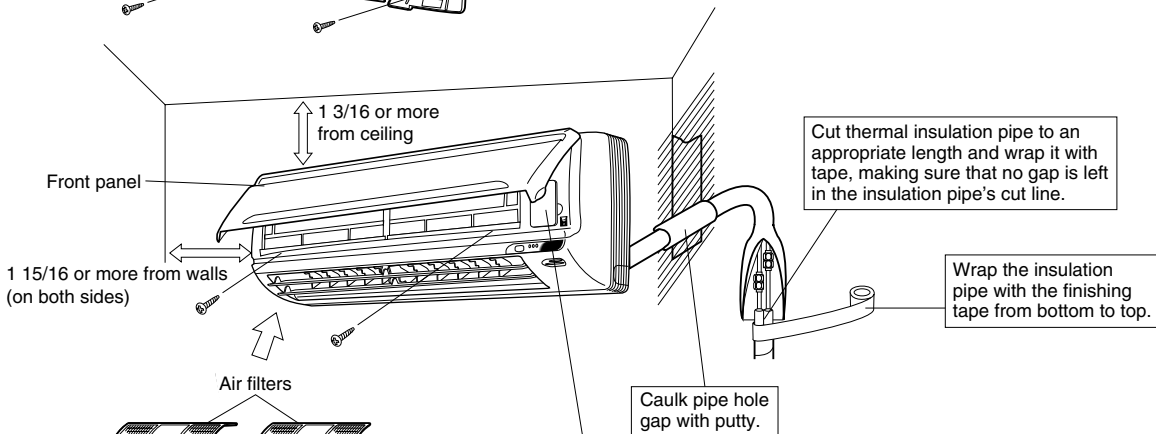

Service lid
This service lid is an open/close type.

- Remove the screws on the service lid.
- Slide the service lid leftward.
- Rotate the service lid upward.



© Air-purifying filter with photocatalytic deodorizing function

Install Air-purifying filter with photocatalytic deodorizing function on air filter

Air filter

© Air-purifying filter with photocatalytic deodorizing function

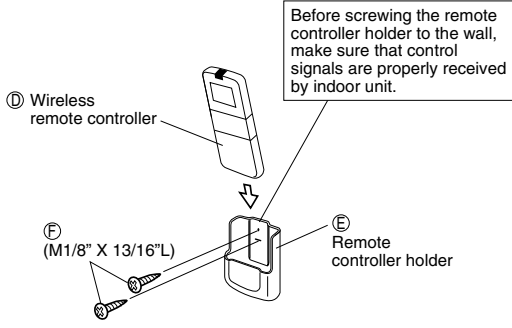

Before screwing the remote controller holder to the wall, make sure that control signals are properly received by indoor unit.

Intelligent-Eye Sensor

1. Adjusting the angle

- 1) Once installation of the indoor unit is complete, adjust the angle of the Intelligent-eye sensor to ensure the detection area properly covers the room. (Adjustable angle: 15° to right and left of centre)

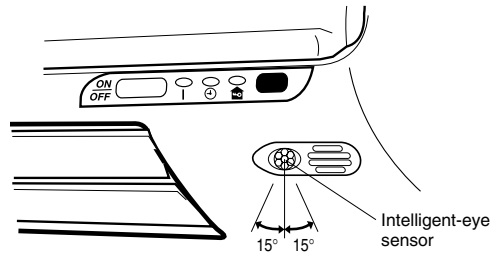

- 2) Gently push and slide the sensor to adjust the angle. Aim so that the sensor is pointing to the centre of the room, or to the part of the room that is most frequently used.

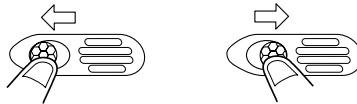

Moving the sensor to the left Moving the sensor to the right

- 3) After adjusting the angle, gently wipe the sensor with a clean cloth, being careful not to scratch the sensor.

Caution

- 1) Do not hit or violently push the Intelligent-eye sensor. This can lead to damage and malfunction.
- 2) Do not place large objects near the sensor. Also keep heating units or humidifiers outside the sensor's detection area.

Indoor Unit Installation

1. Installing the mounting plate

- The mounting plate should be installed on a wall which can support the weight of the indoor unit.
- 1) Temporarily secure the mounting plate to the wall, make sure that the panel is completely level, and mark the boring points on the wall.
- 2) Secure the mounting plate to the wall with screws.

Recommended mounting-plate retention spots and Dimensions

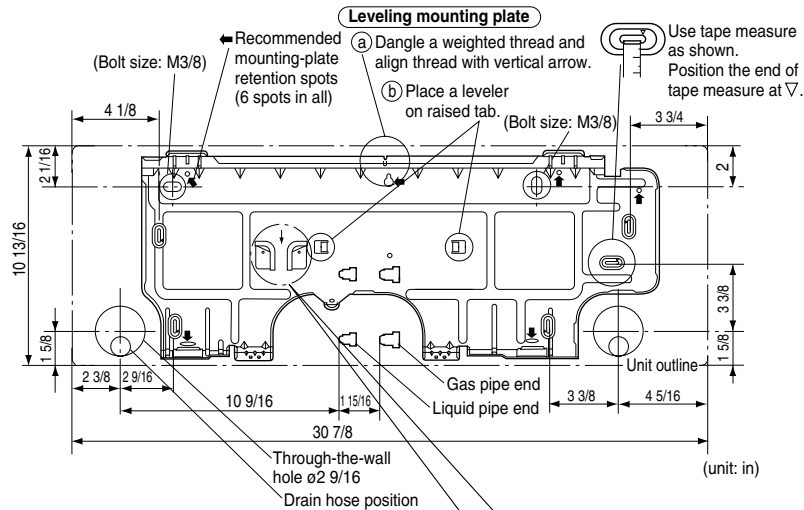

* The removed pipe port cover can be kept in the mounting plate pocket.

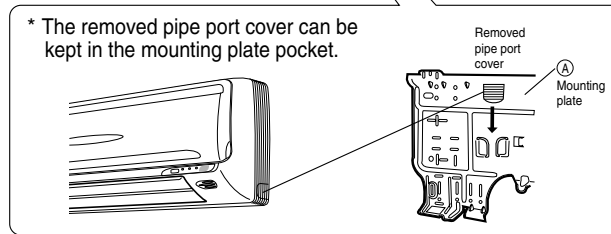

2. Boring a wall hole and installing wall embedded pipe

- For walls containing metal frame or metal board, be sure to use a wall embedded pipe and wall cover in the feed-through hole to prevent possible heat, electrical shock, or fire.
- Be sure to caulk the gaps around the pipes with caulking material to prevent water leakage.
- 1) Bore a feed-through hole of 2 9/16in in the wall so it has a down slope toward the outside.
- 2) Insert a wall pipe into the hole.
- 3) Insert a wall cover into wall pipe.
- 4) After completing refrigerant piping, wiring, and drain piping, caulk pipe hole gap with putty.

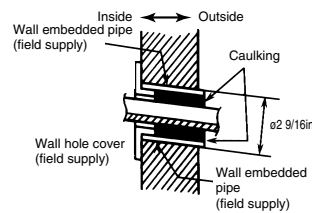

3. Installing indoor unit

3-1. Right-Side, Right-Back, or Right-Bottom Piping

- 1) Attach the drain hose to the underside of the refrigerant pipes with adhesive vinyl tape.
- 2) Wrap the refrigerant pipes and drain hose together with insulation tape.

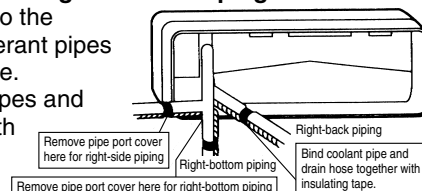

- 3) Pass the drain hose and refrigerant pipes through the wall hole, then set the indoor unit on the mounting plate hooks by using the Δ markings at the top of the indoor unit as a guide.
- 4) Open the front grille, then open the service lid. (Refer to Installation Tips.)
- 5) Pass the interconnecting wires from the outdoor unit through the feed-through wall hole and then through the back of the indoor unit. Pull them through the front side. Bend the ends of tie wires upward in advance for easier work. (If the interconnecting wire ends are to be stripped first, bundle wire ends with adhesive tape.)
- 6) Press the indoor unit's bottom panel with both hands to set it on the mounting plate hooks. Make sure the wires do not catch on the edge of the indoor unit.

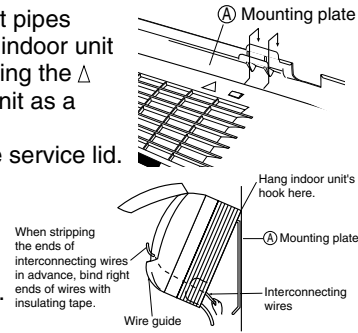

3-2. Left-Side, Left-Back, or Left Bottom Piping

- 1) Attach the drain hose to the underside of the refrigerant pipes with adhesive vinyl tape.

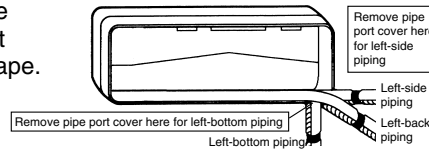

- 2) Be sure to connect the drain hose to the drain port in place of a drain plug.

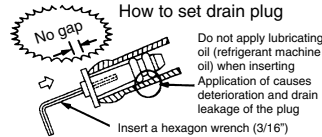

- 3) Shape the refrigerant pipe along the pipe path marking on the mounting plate.
- 4) Pass drain hose and refrigerant pipes through the wall hole, then set the indoor unit on mounting plate hooks, using the Δ markings at the top of indoor unit as a guide.
- 5) Pull in the interconnecting wires.
- 6) Connect the inter-unit piping.

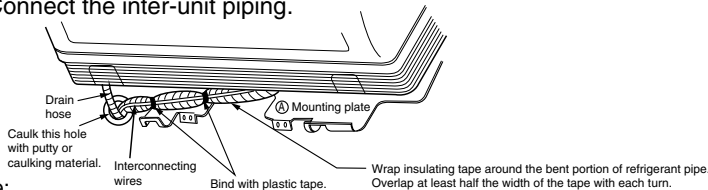

Note:

- 1) Wrap the refrigerant pipes and drain hose together with insulation tape as right figure, in case of setting the drain hose through the back of the indoor unit.
- 2) If it is difficult to fix the claws of the bottom frame on the catches of the mounting plate. Secure indoor unit to the mounting plate with screws (M3/16" x 1/2"L).

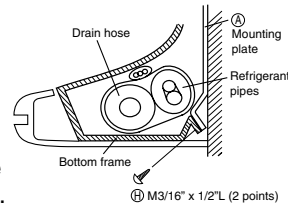

3-3. Wall Embedded Piping

Follow the instructions given under

Left-Side, Left-Back, or Left Bottom Piping

- 1) Insert the drain hose to this depth so it won't be pulled out of the drain pipe.

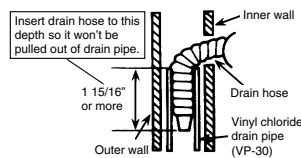

4. Wiring

- 1) Strip wire ends (9/16in).
- 2) Match wire colours with terminal numbers on indoor and outdoor units' terminal blocks and firmly screw wires to the corresponding terminals.
- 3) Connect the earth wires to the corresponding terminals.
- 4) Pull wires to make sure that they are securely latched up, then retain wires with wire retainer.
- 5) Shape the wires so that the service lid fits securely, then close service lid.

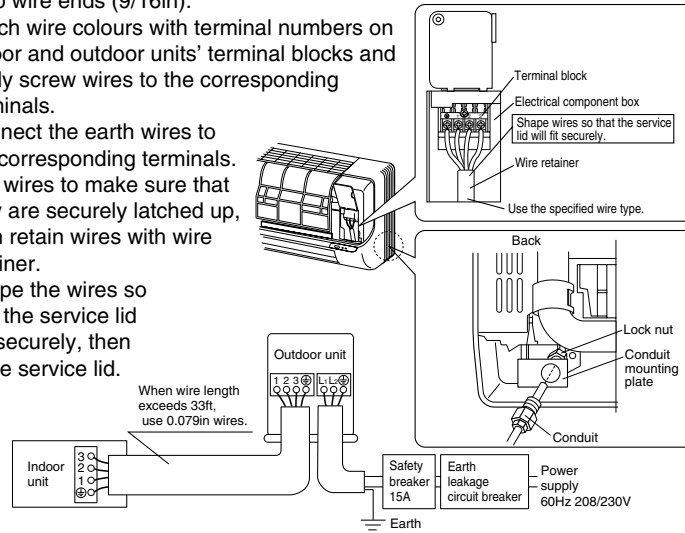

Warning

- 1) Do not use spliced wires, stand wires, extension cords, or starburst connections, as they may cause overheating, electrical shock, or fire. Follow all Local, and State electrical codes.
- 2) Do not use locally purchased electrical parts inside the product. (Do not overload the circuit by adding drain pump or other electrical equipment to unit terminals.) Doing so may cause electric shock or fire.
- 3) When carrying out wiring connection, take care not to pull at the conduit.

5. When connecting to an HA system

- 1) Remove the front grille. (2 screws)
- 2) Remove the electrical wiring box. (3 screws)
- 3) Remove the metal plate electrical wiring cover. (4 tabs)
- 4) Remove the resin plastic electrical wiring cover. (2 tabs)
- 5) Attach the connection cord to the S21 connector and pull the harness out through the notched part in the figure.
- 6) Replace the electrical wiring cover as it was, and pull the harness around, as shown in the figure.

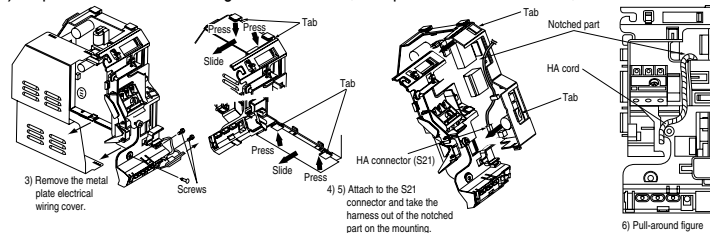

6. Drain piping.

- 1) Connect the drain hose, as described below
- 2) Remove the air filters and pour some water into the drain pan to check the water flows smoothly.
- 3) When drain hose requires extension, obtain an extension hose commercially available. Be sure to thermally insulate the indoor section of the extension hose.
- 4) When connecting a rigid polyvinyl chloride pipe (nominal diameter 1/2in) directly to the drain hose attached to the indoor unit as with embedded piping work, use any commercially available drain socket (nominal diameter 1/2in) as a joint.

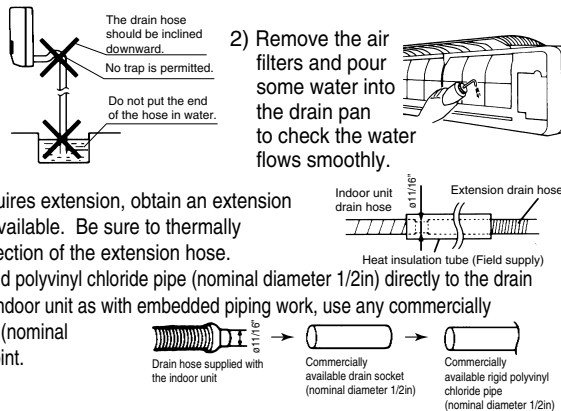

Refrigerant piping work

1. Flaring the pipe end

- 1) Cut the pipe end with a pipe cutter.
- 2) Remove burrs with the cut surface facing downward so that the chips do not enter the pipe.
- 3) Put the flare nut on the pipe.
- 4) Flare the pipe.
- 5) Check that the flaring is properly made.

(Cut exactly at right angles.) Remove burrs

Flaring

Set exactly at the position shown below.

A	Flare tool for R-410A		Conventional flare tool	
	Clutch-type	Clutch-type (Rigid-type)	Wing-nut type (Imperial-type)	
A	0 - 0.020"	0.039 - 0.059"	0.059 - 0.079"	

Check

Flare's inner surface must be flaw-free.

The pipe end must be evenly flared in a perfect circle.

Make sure that the flare nut is fitted.

Warning

- 1) Do not use mineral oil on flared part.
- 2) Prevent mineral oil from getting into the system as this would reduce the unit life.
- 3) Never use piping which has been used for previous installations. Only use parts which are provided with the unit.
- 4) Do never install a refrigerant drier to this unit.
- 5) The drying material may dissolve and damage the system.
- 6) Incomplete or improper flaring may cause refrigerant gas leakage.

2. Refrigerant piping

- 1) Align the centres of both flares and tighten the flare nuts 3 or 4 turns by hand. Then tighten them fully with the torque wrenches.
 - Use torque wrenches when tightening the flare nuts to prevent damage to the flare nuts and escaping gas.
- 2) To prevent gas leakage, apply refrigeration machine oil on both inner and outer surfaces of the flare.

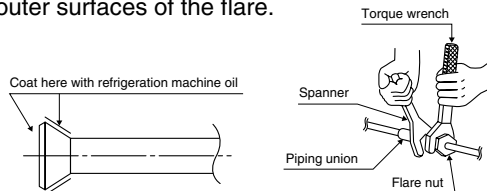

Flare nut tightening torque	
Gas side	Liquid side
3/8 inch	1/4 inch
24.1~29.4ft • lbf	10.4~12.7ft • lbf

Valve cap tightening torque	
Gas side	Liquid side
3/8 inch	1/4 inch
15.9~20.2ft • lbf	

2-1. Cautions on Pipe Handling

- 1) Protect the open end of the pipe against dust and moisture.
- 2) All pipe bends should be as gentle as possible. Use a pipe bender for bending. (Bending radius should be 1 3/16 to 1 9/16in or larger.)

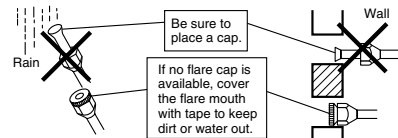

2-2. Selection of Copper and Heat Insulation materials

- When using commercial copper pipes and fittings, observe the following:
 - 1) Insulation material: Polyethylene foam
Heat transfer rate: 0.041 to 0.052 kW/mK (0.024-0.030 Btu/fth °F)
Refrigerant gas pipe's surface temperature reaches 230 °F max.
Choose heat insulation materials that will withstand this temperature.
 - 2) Be sure to insulate both the gas and liquid piping and to provide insulation dimensions as below.

Gas side	Liquid side	Gas pipe thermal insulation	Liquid pipe thermal insulation
09/12 class		09/12 class	
O.D. 3/8	O.D. 1/4	I.D. 0.472-0.590	I.D. 0.315-0.393
Thickness 0.031		Thickness 0.393 Min.	

- 3) Use separate thermal insulation pipes for gas and liquid refrigerant pipes.

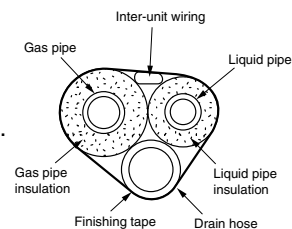

Trial Operation and Testing

1. Trial Operation and Testing.

1-1 Measure the supply voltage and make sure that it falls in the specified range.

1-2 Trial operation should be carried out in either cooling or heating mode.

- In cooling mode, select the lowest programmable temperature; in heating mode, select the highest programmable temperature.
 - 1) Trial operation may be disabled in either mode depending on the room temperature.
 - 2) After trial operation is complete, set the temperature to a normal level (78°F to 82°F in cooling mode, 68°F to 75°F in heating mode).
 - 3) For protection, the unit disables restart operation for 3 minutes after it is turned off.

1-3 Carry out the test operation in accordance with the Operation Manual to ensure that all functions and parts, are working properly.

- The air conditioner requires a small amount of power in its standby mode. If the system is not to be used for some time after installation, shut off the circuit breaker to eliminate unnecessary power consumption.
- If the circuit breaker trips to shut off the power to the air conditioner, the system will restore the original operation mode when the circuit breaker is opened again.

Trial operation from Remote Controller

- 1) Press ON/OFF button to turn on the system.
- 2) Simultaneously press center of TEMP button and MODE button.
- 3) Press MODE button twice.
(“T” will appear on the display to indicate that Trial Operation mode is selected.)
- 4) Trial run mode terminates in approx. 30 minutes and switches into normal mode. To quit a trial operation, press ON/OFF button.

2. Test Items.

Test Items	Symptom	Check
Indoor and outdoor units are installed properly on solid bases.	Fall, vibration, noise	
No refrigerant gas leaks.	Incomplete cooling/heating function	
Refrigerant gas and liquid pipes and indoor drain hose extension are thermally insulated.	Water leakage	
Drain line is properly installed.	Water leakage	
System is properly ground to earth.	Electrical leakage	
The specified wires are used for interconnecting wire connections.	Inoperative or burn damage	
Indoor or outdoor unit's air intake or exhaust has clear path of air. Shut-off valves are opened.	Incomplete cooling/heating function	
Indoor unit properly receives remote control commands.	Inoperative	

12.1.3 The Single Split Duct-Free System FTXS15/18/24DVJU

Accessories

(A) Mounting plate	1	(E) Remote controller holder	1	(K) Operation manual	1
(B) Mounting plate fixing screws M3/16" × 1"L	10	(F) Fixing screws for remote controller holder M1/8" × 13/16"L	2	(L) Installation manual	1
(C) Air-purifying filter with photocatalytic deodorizing function	2	(G) AAA dry-cell batteries	2		
(D) Wireless remote controller	1	(H) Indoor unit fixing screws M3/16" × 1/2"L	2		

Choosing a Site

Before choosing the installation site, obtain user approval.

1. Indoor unit.

- The indoor unit should be sited in a place where:
 - 1) the restrictions on installation specified in the indoor unit installation drawings are met,
 - 2) both air intake and exhaust have clear paths met,
 - 3) the unit is not in the path of direct sunlight,
 - 4) the unit is away from the source of heat or steam,
 - 5) there is no source of machine oil vapour (this may shorten indoor unit life),
 - 6) cool air is circulated throughout the room,
 - 7) the unit is away from electronic ignition type fluorescent lamps (inverter or rapid start type) as they may shorten the remote control range,
 - 8) the unit is at least 3.5 ft away from any television or radio set (unit may cause interference with the picture or sound).

2. Wireless remote controller.

- 1) Turn on all the fluorescent lamps in the room, if any, and find the site where remote control signals are properly received by the indoor unit (within 23 ft).

Installation Tips

1. Removing and installing front panel

• Removal method

Hook fingers on the panel protrusions on the left and right of the main body, and open until the panel stops. Slide the front panel sideways to disengage the rotating shaft. Then pull the front panel toward you to remove it.

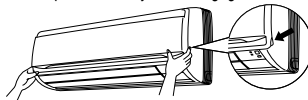

• Installation method

Align the tabs of the front panel with the grooves, and push all the way in. Then close slowly. Push the center of the lower surface of the panel firmly to engage the tabs.

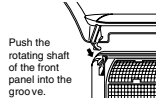

2. Removing and installing front grille

• Removal method

- 1) Remove front panel to remove the air filter.
- 2) Remove the front grille. (3 screws)
- 3) In front of the ○○○ mark of the front grille, there are 3 upper hooks. Lightly pull the front grille toward you with one hand, and push down on the hooks with the fingers of your other hand. (3 locations)

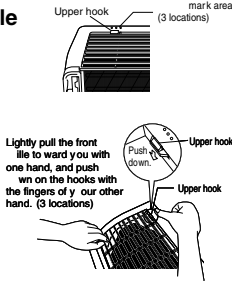

<When there is no work space because the unit is close to ceiling>

⚠ Caution

Be sure to wear protection gloves.

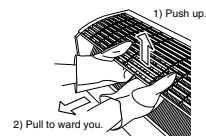

Place both hands under the center of the front grille, and while pushing up, pull it toward you.

• Installation method

- 1) Install the front grille and firmly engage the upper hooks (3 locations).
- 2) Install 2 screws (18 class) or 3 screws (20, 24 class) of the front grill.
- 3) Install the air filter and then mount the front panel.

3. How to set the different addresses

When two indoor units are installed in one room, the two wireless remote controllers can be set for different addresses.

- 1) In the same way as when connecting to an HA system, remove the metal plate electrical wiring cover.
- 2) Cut the address jumper (JA).
- 3) Cut the address jumper (J4).

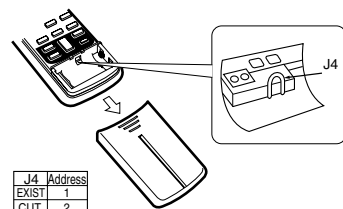
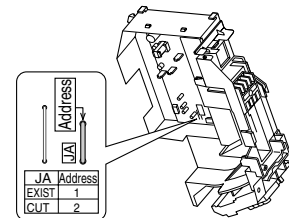

J4	Address
EXIST	1
CUT	2

Indoor Unit Installation Drawings

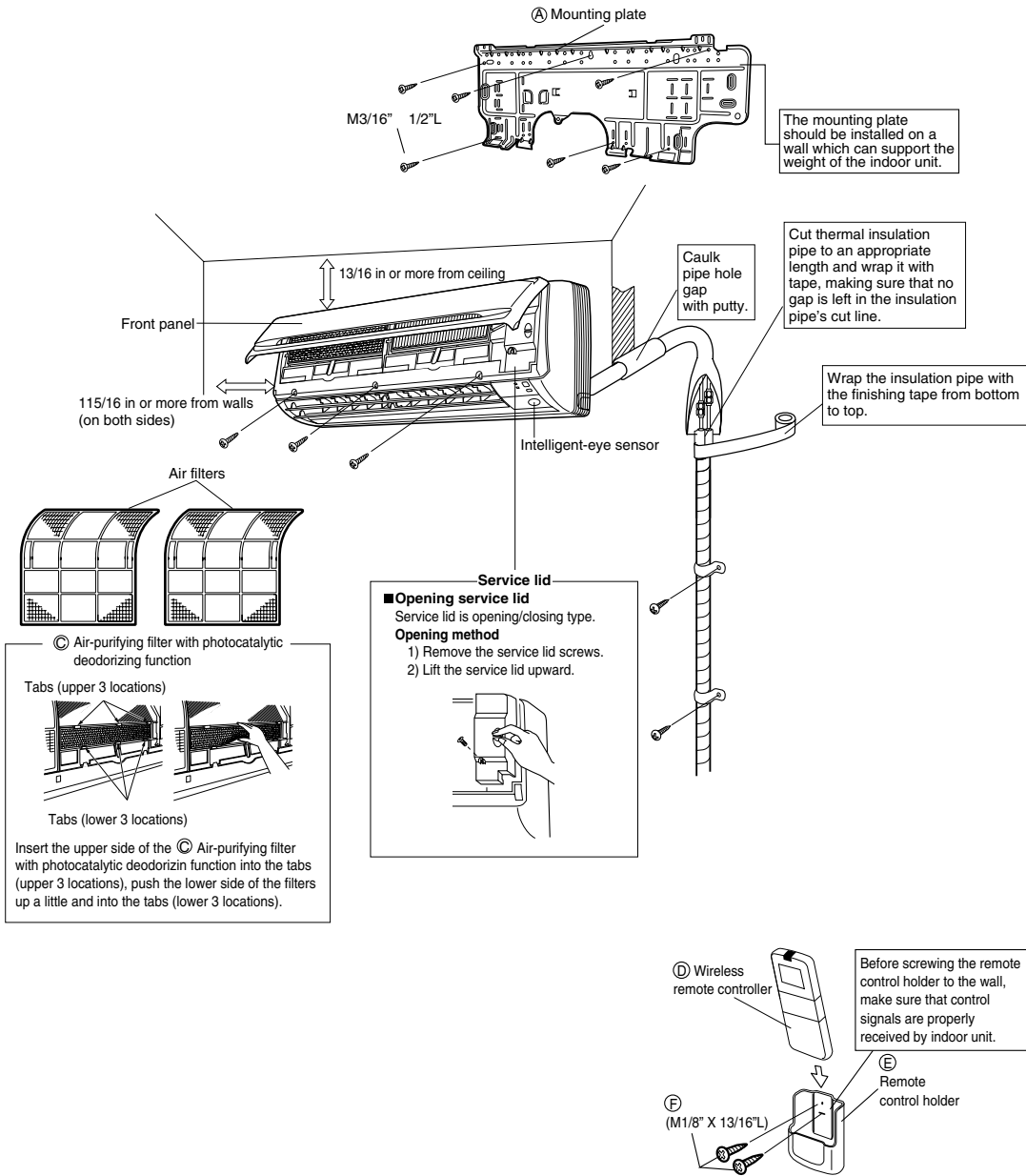

Intelligent-eye sensor

⚠ Caution

- 1) Do not hit or violently push the Intelligent-eye sensor. This can lead to damage and malfunction.
- 2) Do not place large objects near the sensor. Also keep heating units or humidifiers outside the sensor's detection area.

Indoor Unit Installation

1. Installing the mounting plate.

- The mounting plate should be installed on a wall which can support the weight of the indoor unit.
- 1) Temporarily secure the mounting plate to the wall, make sure that the panel is completely level, and mark the boring points on the wall.
- 2) Secure the mounting plate to the wall with screws.

Recommended mounting-plate retention spots and Dimensions

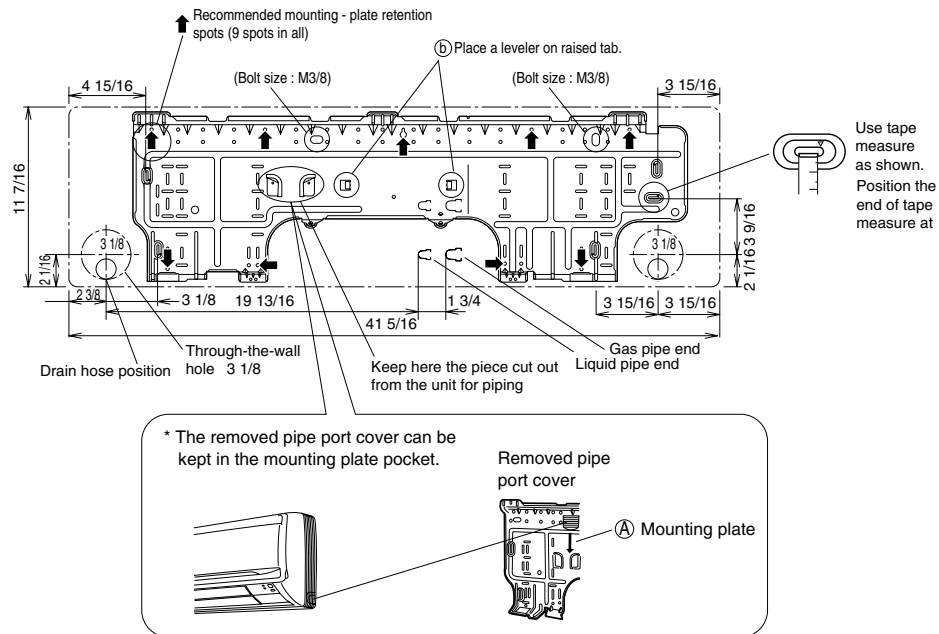

Indoor Unit Installation

2. Boring a wall hole and installing wall embedded pipe.

- For walls containing metal frame or metal board, be sure to use a wall embedded pipe and wall cover in the feed-through hole to prevent possible heat, electrical shock, or fire.
 - Be sure to caulk the gaps around the pipes with caulking material to prevent water leakage.
- 1) Bore a feed-through hole of 3 1/8in in the wall so it has a down slope toward the outside.
 - 2) Insert a wall pipe into the hole.
 - 3) Insert a wall cover into wall pipe.
 - 4) After completing refrigerant piping, wiring, and drain piping, caulk pipe hole gap with putty.

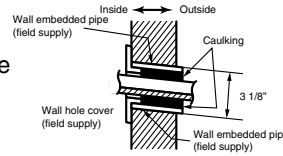

3. Installing indoor unit.

3-1. Right-Side, Right-Back, or Right-Bottom Piping

- 1) Attach the drain hose to the underside of the refrigerant pipes with adhesive vinyl tape.
- 2) Wrap the refrigerant pipes and drain hose together with insulation tape.

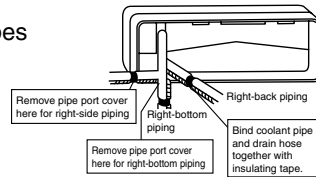

- 3) Pass the drain hose and refrigerant pipes through the wall hole, then set the indoor unit on the mounting plate hooks by using the Δ markings at the top of the indoor unit as a guide.

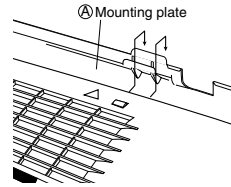

- 4) Open the front grille, then open the service lid. (Refer to Installation tips)
- 5) Pass the interconnecting wires from the outdoor unit through the feed-through wall hole and then through the back of the indoor unit. Pull them through the front side. Bend the ends of tie wires upward in advance for easier work. (If the interconnecting wire ends are to be stripped first, bundle wire ends with adhesive tape.)
- 6) Press the indoor unit's bottom panel with both hands to set it on the mounting plate hooks. Make sure the wires do not catch on the edge of the indoor unit.

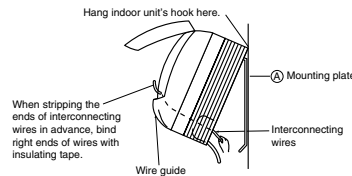

3-2. Left-Side, Left-Back, or Left Bottom Piping

- 1) Attach the drain hose to the underside of the refrigerant pipes with adhesive vinyl tape.

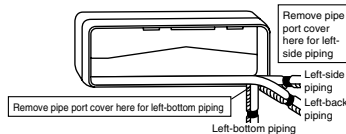

- 2) Be sure to connect the drain hose to the drain port in place of a drain plug.

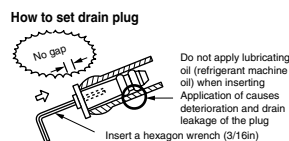

- 3) Shape the refrigerant pipe along the pipe path marking on the mounting plate.
- 4) Pass drain hose and refrigerant pipes through the wall hole, then set the indoor unit on mounting plate hooks, using the Δ markings at the top of indoor unit as a guide.

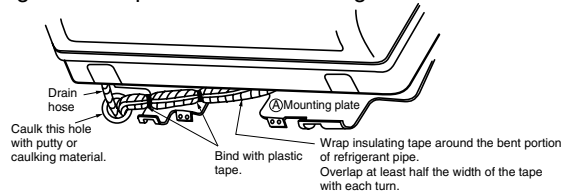

- 5) Pull in the interconnecting wires.
- 6) Connect the inter-unit piping.
- 7) Wrap the refrigerant pipes and drain hose together with insulation tape as right figure, in case of setting the drain hose through the back of the indoor unit.

- 8) While exercising care so that the interconnecting wires do not catch indoor unit, press the bottom edge of indoor unit with both hands until it is firmly caught by the mounting plate hooks. Secure indoor unit to the mounting plate with screws (M3/16" x 1/2"L).

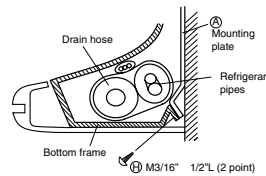

3-3. Wall Embedded Piping

Follow the instructions given under

Left-Side, Left-Back, or Left Bottom Piping

- 1) Insert the drain hose to this depth so it won't be pulled out of the drain pipe.

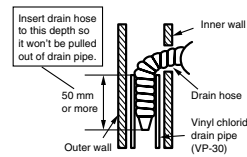

4. Wiring.

- 1) Strip wire ends (9/16in).
- 2) Match wire colours with terminal numbers on indoor and outdoor unit's terminal blocks and firmly screw wires to the corresponding terminals.
- 3) Connect the earth wires to the corresponding terminals.
- 4) Pull wires to make sure that they are securely latched up, then retain wires with wire retainer.
- 5) In case of connecting to an adapter system. Run the remote control cable and attach the S21 connector as the illustration above.
- 6) Shape the wires so that the service lid fits securely, then close service lid.

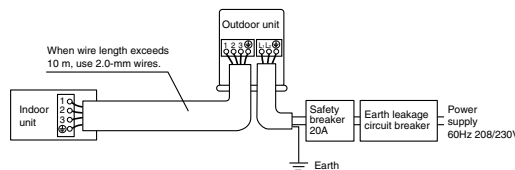
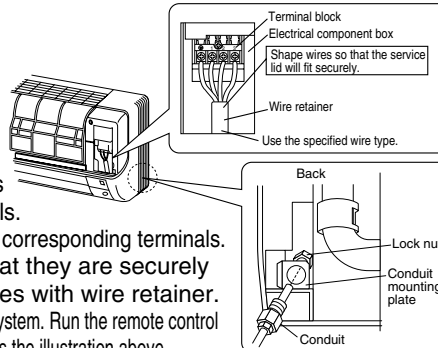

Warning

- 1) Do not use spliced wires, stand wires, extension cords, or starburst connections, as they may cause overheating, electrical shock, or fire. Follow all Local, and State electrical codes.
- 2) Do not use locally purchased electrical parts inside the product. (Do not overload the circuit by adding drain pump or other electrical equipment to unit terminals.) Doing so may cause electric shock or fire.
- 3) When carrying out wiring connection, take care not to pull at the conduit.

5. When connecting to an HA system.

- 1) Remove the front grille. (3 screws)
- 2) Remove the electrical wiring box. (1 screw)
- 3) Remove the metal plate electrical wiring cover. (4 tabs)
- 4) Attach the connection cord to the S21 connector and pull the harness out through the notched part in the figure.
- 5) Replace the electrical wiring cover as it was, and pull the harness around, as shown in the figure

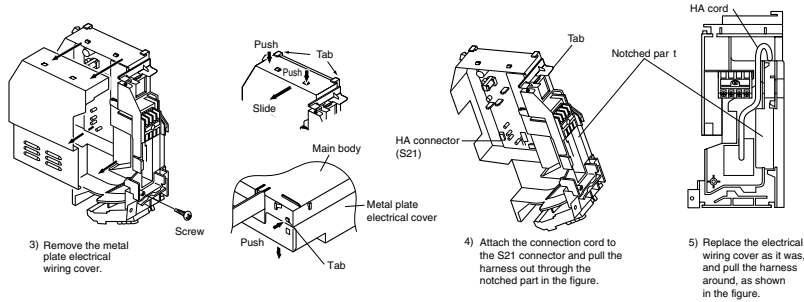

6. Drain piping.

- 1) Connect the drain hose, as described below.

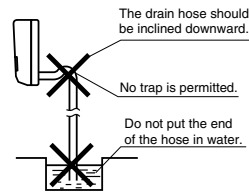

- 2) Remove the air filters and pour some water into the drain pan to check the water flows smoothly.

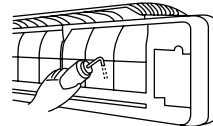

- 3) When drain hose requires extension, obtain an extension hose commercially available. Be sure to thermally insulate the indoor section of the extension hose.

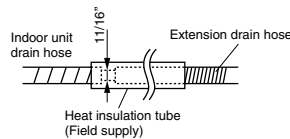

- 4) When connecting a rigid polyvinyl chloride pipe (nominal diameter 1/2in) directly to the drain hose attached to the indoor unit as with embedded piping work, use any commercially available drain socket (nominal diameter 1/2in) as a joint.

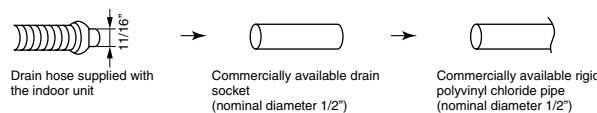

Refrigerant piping work

1. Flaring the Pipe End

- 1) Cut the pipe end with a pipe cutter.
- 2) Remove burrs with the cut surface facing downward so that the chips do not enter the pipe.
- 3) Put the flare nut on the pipe.
- 4) Flare the pipe.
- 5) Check that the flaring is properly made.

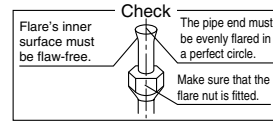
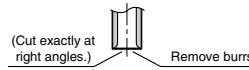

Set exactly at the position shown below.

		Flaring		
		Flare tool for R-410A		Conventional flare tool
		Clutch-type	Clutch-type (Rigid-type)	Wing-nut type (Imperial-type)
A	A	0 - 0.020"	0.039 - 0.059"	0.059 - 0.079"

⚠ Warning

- 1) Do not use mineral oil on flared part.
- 2) Prevent mineral oil from getting into the system as this would reduce the unit life.
- 3) Never use piping which has been used for previous installations. Only use parts which are provided with the unit.
- 4) Do never install a refrigerant drier to this unit.
- 5) The drying material may dissolve and damage the system.
- 6) Incomplete or improper flaring may cause refrigerant gas leakage.

2. Refrigerant Piping

- 1) Align the centers of both flares and tighten the flare nuts 3 or 4 turns by hand. Then tighten them fully with the torque wrenches.
 - Use torque wrenches when tightening the flare nuts to prevent damage to the flare nuts and escaping gas.
- 2) To prevent gas leakage, apply refrigeration machine oil on both inner and outer surfaces of the flare. (Use refrigeration oil for R410A)

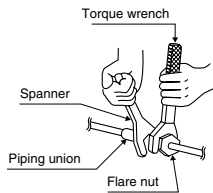
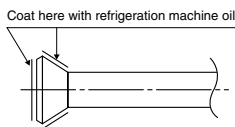

Flare nut tightening torque		
Gas side		Liquid side
1/2 inch	5/8 inch	1/4 inch
36.5~44.5ft • lbf	45.6~55.6ft • lbf	10.4~12.7ft • lbf

Valve cap tightening torque		
Gas side		Liquid side
1/2 inch	5/8 inch	1/4 inch
35.5~44.0ft • lbf	32.5~39.7ft • lbf	15.9~20.2ft • lbf

Service port cap tightening torque	7.9~10.8ft • lbf
------------------------------------	------------------

2-1. Caution on Piping Handling

- 1) Protect the open end of the pipe against dust and moisture.
- 2) All pipe bends should be as gentle as possible. Use a pipe bender for bending.
(Bending radius should be 1 3/16 to 1 9/16in or larger.)

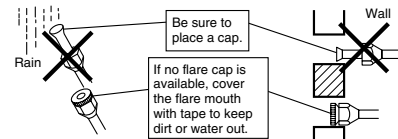

2-2. Selection of Copper and Heat Insulation materials

- When using commercial copper pipes and fittings, observe the following:

- 1) Insulation material: Polyethylene foam
Heat transfer rate: 0.041 to 0.052 kW/mK (0.024-0.030 Btu/ft²°F)
Refrigerant gas pipe's surface temperature reaches 230°F max. Choose heat insulation materials that will withstand this temperature.

- 2) Be sure to insulate both the gas and liquid piping and to provide insulation dimensions as below.

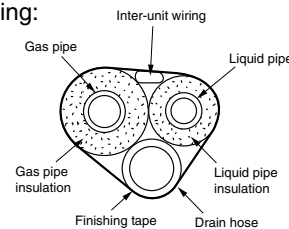

Gas side		Liquid side	Gas pipe thermal insulation		Liquid pipe thermal insulation
15/18 class	24 class	15/18/24 class	15/18 class	24 class	15/18/24 class
O.D. 1/2in	O.D. 5/8in	O.D. 1/4in	I.D. 0.551-0.630in	I.D. 0.630-0.709in	I.D. 0.315-0.393in
Thickness 0.031in	Thickness 0.039in	Thickness 0.031in	Thickness 0.393in Min.		

- 3) Use separate thermal insulation pipes for gas and liquid refrigerant pipes.

Run Test and Final Check

1. Trial Operation and Testing.

- 1-1 Measure the supply voltage and make sure that it falls in the specified range.
- 1-2 Trial operation should be carried out in either cooling or heating mode.
 - In cooling mode, select the lowest programmable temperature; in heating mode, select the highest programmable temperature.
 - 1) Trial operation may be disabled in either mode depending on the room temperature. Use the remote control for trial operation as described below.
 - 2) After trial operation is complete, set the temperature to a normal level (78°F to 82°F in cooling mode, 68°F to 75°F in heating mode).
 - 3) For protection, the unit disables restart operation for 3 minutes after it is turned off.
- 1-3 Carry out the test operation in accordance with the Operation Manual to ensure that all functions and parts, are working properly.
 - The air conditioner requires a small amount of power in its standby mode. If the system is not to be used for some time after installation, shut off the circuit breaker to eliminate unnecessary power consumption.
 - If the circuit breaker trips to shut off the power to the air conditioner, the system will restore the original operation mode when the circuit breaker is opened again.

Trial Operation from Remote Controller.





















- 1) Press ON/OFF button to turn on the system.
- 2) Simultaneously press center of TEMP button and MODE button.
- 3) Press MODE button twice.
 (“7” will appear on the display to indicate that Trial Operation mode is selected.)
- 4) Trial run mode terminates in approx. 30 minutes and switches into normal mode. To quit a trial operation, press ON/OFF button.

2. Test Items.

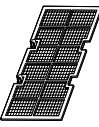
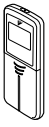
Test Items	Symptom	Check
Indoor and outdoor units are installed properly on solid bases.	Fall, vibration, noise	
No refrigerant gas leaks.	Incomplete cooling/heating function	
Refrigerant gas and liquid pipes and indoor drain hose extension are thermally insulated.	Water leakage	
Drain line is properly installed.	Water leakage	
System is properly ground to earth.	Electrical leakage	
The specified wires are used for interconnecting wire connections.	Inoperative or burn damage	
Indoor or outdoor unit's air intake or exhaust has clear path of air. Shut-off valves are opened.	Incomplete cooling/heating function	
Indoor unit properly receives remote control commands.	Inoperative	

12.1.4 The Slim Duct Built-in System FDXS09/12DVJU

ACCESSORIES

Clamp metal	Insulation for fitting	Sealing pad		Drain hose	Washer for hanger bracket	Sealing material	Clamp	Washer fixing plate	Screws for duct flanges	Conduit mounting plate
1 pc.	1 each	Large and small 1 each		1 pc.	8 pcs.	2 pcs.	6 pcs.	1 set	1 set	1 pc.
	 for gas pipe  for liquid pipe	 Large	 Small					 4 pcs.	 24 pcs.	
Screws for conduit mounting plate	Insulation tube	Air filter	Wireless remote controller	Remote controller holder	AAA dry-cell batteries	Receiver kit			[Other]	
2 pcs.	1 pc.	1 pc.	1 pc.	1 pc.	1 set	1 pc.	1 pc.	2 pcs.	<ul style="list-style-type: none"> • Operation manual • Installation manual 	
					 2 pcs.			 Screws M4 x 25		

CHOOSING A SITE

- Before choosing the installation site, obtain user approval.

Indoor unit

Caution

- When moving the unit during or after unpacking, make sure to lift it by holding its lifting lugs. Do not exert any pressure on other parts, especially the refrigerant piping, drain piping and flange parts. Wear protective gears (gloves and so on) when installing the unit.
- If you think the humidity inside the ceiling might exceed 86°F and RH80%, reinforce the insulation on the unit body. Use glass wool or polyethylene foam as insulation so that the thickness is more than 0.4in and fits inside the ceiling opening.

- Optimum air distribution is ensured.
- The air passage is not blocked.
- Condensate can drain properly.
- The ceiling is strong enough to bear the weight of the indoor unit.
- A false ceiling does not seem to be at an incline.
- Sufficient clearance for maintenance and servicing is ensured.
- Piping between the indoor and outdoor units is within the allowable limits. (Refer to the installation manual for the outdoor unit.)
- The indoor unit, outdoor unit, power supply wiring and transmission wiring is at least 3.3ft away from televisions and radios. This prevents image interference and noise in electrical appliances. (Noise may be generated depending on the conditions under which the electric wave is generated, even if a 3.3ft allowance is maintained.)

- **Use suspension bolts to install the unit. Check whether or not the ceiling is strong enough to support the weight of the unit. If there is a risk that the ceiling is not strong enough, reinforce the ceiling before installing the unit.** (Installation pitch is marked on the carton box for installation. Refer to it to check for points requiring reinforcing.) Select the *H dimension such that a downward slope of at least 1/100 is ensured as indicated in “DRAIN PIPING WORK”.
 - The installation pitch is listed on the packing material, and should be checked when deciding whether to reinforce the location or not.

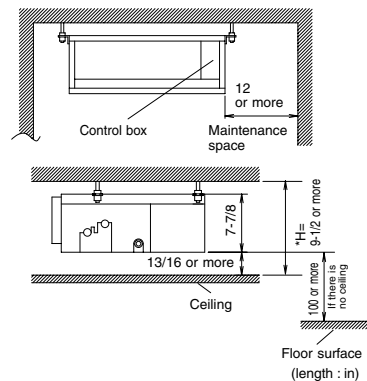

CHOOSING A SITE

■ **Select the signal receiver mounting location according to the following conditions:**

- Install the signal receiver, which has a built-in temperature sensor, near the intake vent where there is convection of air and it can get an accurate reading of the room's temperature. If the intake vent is in another room or the unit cannot be installed near the intake vent for any other reason, install it 5ft above the floor on a wall where there is convection.
- In order to get an accurate reading of the room's temperature, install the signal receiver in a location where it is not exposed directly to cold or hot air from the air discharge grille or to direct sunlight.
- Since the receiver has a built-in light receptor to receive signals from the wireless remote controller, do not mount it in a location where the signal may be blocked by a curtain, etc.

Air discharge grille:
Wooden or plastic grille is recommended because condensation may occur depending on humidity conditions.



⚠ Caution

If the signal receiver is not installed in a location where there is convection of air, it may be unable to get an accurate reading of the room's temperature.

Wireless remote controller

- Turn on all the fluorescent lamps in the room, if any, and find the site where remote controller signals are properly received by the indoor unit (within 13ft).

Outdoor unit

- For outdoor unit installation, see the installation manual supplied with the outdoor unit.

PREPARATIONS BEFORE INSTALLATION

■ **Relation of the unit to the suspension bolt positions.**

- Install the inspection opening on the control box side where maintenance and inspection of the control box are easy. Install the inspection opening also in the lower part of the unit.

■ **Make sure the range of the unit's external static pressure is not exceeded.**

(See the technical documentation for the range of the external static pressure setting.)

■ **Open the installation hole. (Pre-set ceilings)**

- Once the installation hole is opened in the ceiling where the unit is to be installed, pass refrigerant piping, drain piping, transmission wiring, and remote controller wiring (unnecessary if using a wireless remote controller) to the unit's piping and wiring holes. See "REFRIGERANT PIPING WORK", "DRAIN PIPING WORK", and "WIRING".
- After opening the ceiling hole, make sure ceiling is level if needed. It might be necessary to reinforce the ceiling frame to prevent shaking. Consult an architect or carpenter for details.

■ **Install the suspension bolts.**

(Use W3/8 to M10 suspension bolts.)

Use a hole-in-anchor, sunken insert, sunken anchor for existing ceilings, and a sunken insert, sunken anchor or other part to be procured in the field to reinforce the ceiling to bearing the weight of the unit. (Refer to Fig.)

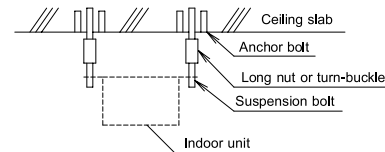
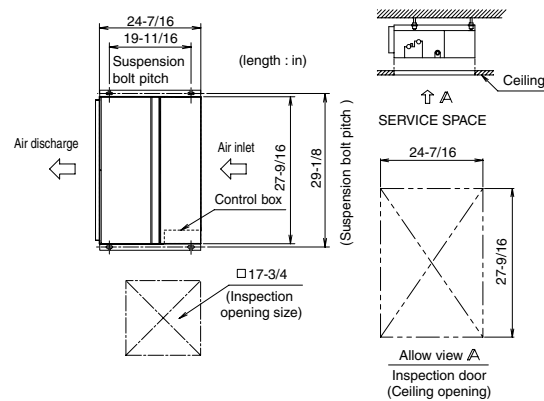

Note: All the above parts are field supplied.

■ **Mount chamber lid and air filter (accessory).**

For bottom intake, replace the chamber lid and the protection net in the procedure listed in Fig.

(1) Remove the protection net. (6 locations)

Remove the chamber lid. (7 locations)

(2) Reattach the removed chamber lid in the orientation shown in Fig. (7 locations)

Reattach the removed protection net in the orientation shown in Fig. (6 locations)

Refer to Fig. for the direction of the protection net.

(3) Attach the hanger (right) insulation to the right hanger. (Stored in outlet vent)
(See the below figure for the sticking base line.)

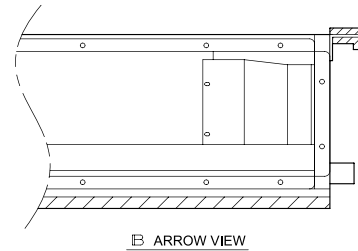
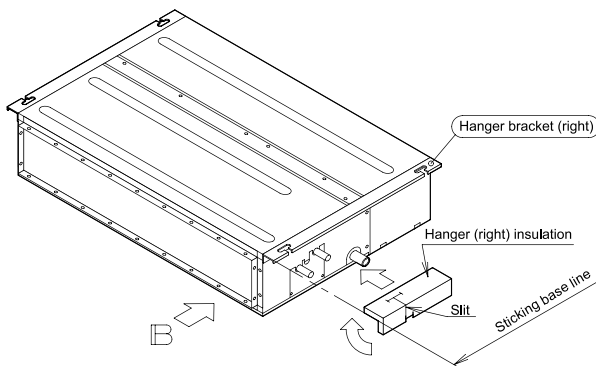
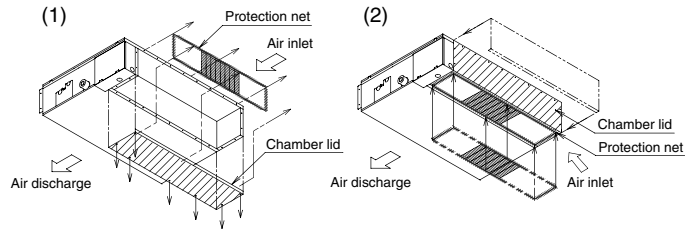

(4) Attach the air filter (accessory) in the manner shown in the diagram.

In case of bottom side

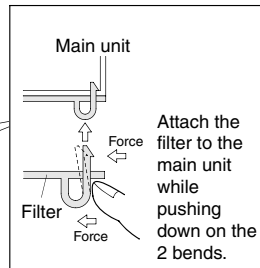
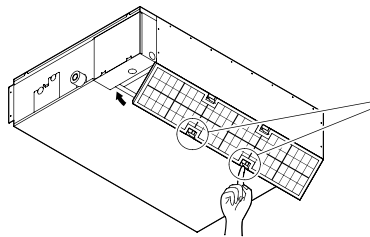

In case of back side

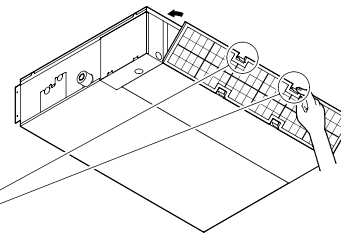

■ **When two indoor units are installed in one room, one of the two wireless remote controllers can be easily set for another addresses.**

PCB in the indoor unit

- Cut the jumper JA on PCB.

JA	ADDRESS: JA
JB	EXIST 1
JC	CUT 2
ADDRESS	

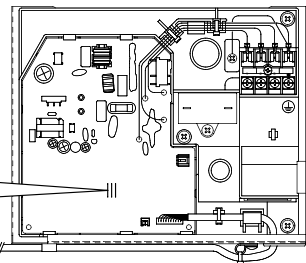

Wireless remote controller

- Cut the jumper J4.

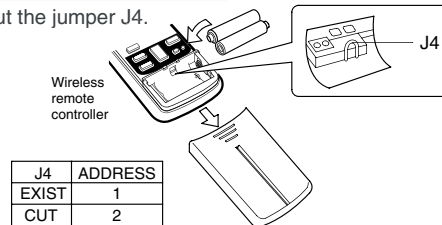

J4	ADDRESS
EXIST	1
CUT	2

INDOOR UNIT INSTALLATION

《 As for the parts to be used for installation work, be sure to use the provided accessories and specified parts designated by our company. 》

■ **Install the indoor unit temporarily.**

- Attach the hanger bracket to the suspension bolt. Be sure to fix it securely by using a nut and washer from the upper and lower sides of the hanger bracket. (Refer to Fig.)

[PRECAUTION]

Since the unit uses a plastic drain pan, prevent welding spatter and other foreign substances from entering the outlet hole during installation.

[Securing the hanger bracket]

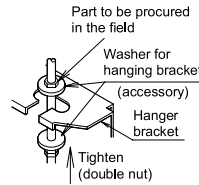

[How to secure washers]

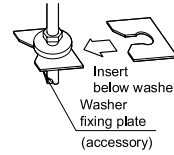

■ **Adjust the height of the unit.**

■ **Check the unit is horizontally level.**

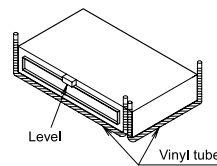

⚠ Caution

Make sure the unit is installed level using a level or a plastic tube filled with water. In using a plastic tube instead of a level, adjust the top surface of the unit to the surface of the water at both ends of the plastic tube and adjust the unit horizontally. (One thing to watch out for in particular is if it is installed so that the slope is not in the direction of the drain piping, as this might cause leaking.)

■ **Tighten the upper nut.**

■ **Mounting the receiver.**

Mount the receiver as shown below.

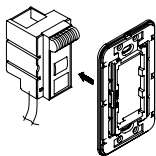

① Press the receiver into the mounting frame.

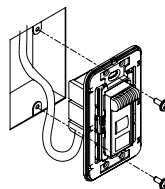

② Mount the completed assembly using two screws.

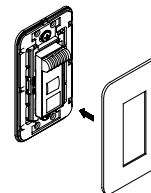

③ Press the decorative cover into the mounting frame.

Note) Mount the Remote controller cord far enough away from strong electrical wires (such as distribution wires for electrical lights, air conditioners, etc.) and from weak electrical wires (such as wires for telephones, intercoms, etc.).

For heat pump: If your feet feel cold when using the heating function, it is recommended that the air discharge grille shown at below be attached.

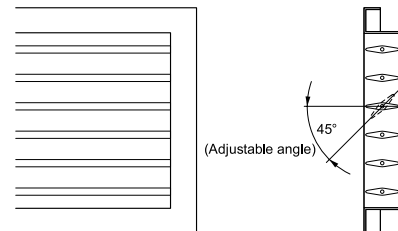

OUTDOOR UNIT INSTALLATION

Install as described in the installation manual supplied with the outdoor unit.

REFRIGERANT PIPING WORK

See the installation manual supplied with the outdoor unit.

1. FLARING THE PIPE END

- 1) Cut the pipe end with a pipe cutter.
- 2) Remove burrs with the cut surface facing downward so that the chips do not enter the pipe.
- 3) Put the flare nut on the pipe.
- 4) Flare the pipe.
- 5) Check that the flaring is properly made.

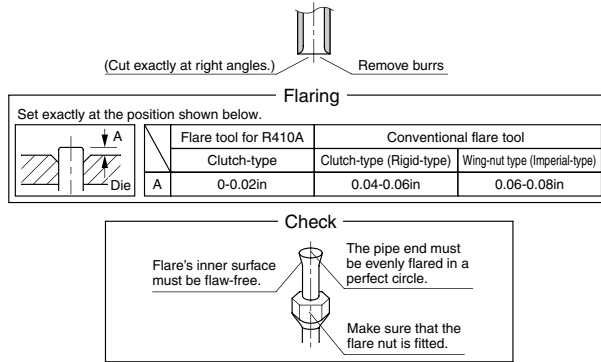

Warning

Do not use mineral oil on flared part.
 Prevent mineral oil from getting into the system as this would reduce the lifetime of the units.
 Never use piping which has been used for previous installations. Only use parts which are delivered with the unit.
 Do never install a drier to this R410A unit in order to guarantee its lifetime.
 The drying material may dissolve and damage the system.
 Incomplete flaring may cause refrigerant gas leakage.

2. REFRIGERANT PIPING

- 1) To prevent gas leakage, apply refrigeration machine oil on both inner and outer surfaces of the flare. (Use refrigeration oil for R410A)
- 2) Align the centres of both flares and tighten the flare nuts 3 or 4 turns by hand. Then tighten them fully with the torque wrenches.
 - Use torque wrenches when tightening the flare nuts to prevent damage to the flare nuts and escaping gas.

Flare nut tightening torque		
Gas side		Liquid side
3/8 in	1/2 in	1/4 in
24.1-29.4ft•lb	36.5-44.5ft•lb	10.4-12.7ft•lb

Caution

Overtightening may damage the flare and cause leaks.

- 3) After the work is finished, make sure to check that there is no gas leak.

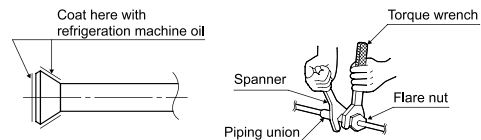

- 4) After checking for gas leaks, be sure to insulate the pipe connections.

- Insulate using the insulation for fitting included with the liquid and gas pipes. Besides, make sure the insulation for fitting on the liquid and gas piping has its seams facing up. (Tighten both edges with clamp.)
- For the gas piping, wrap the medium sealing pad over the insulation for fitting (flare nut part).

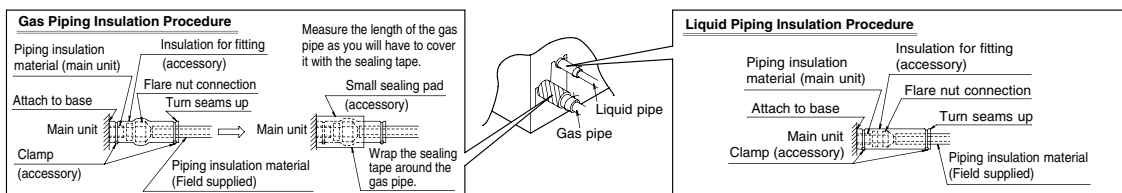

REFRIGERANT PIPING WORK

⚠ Caution

Be sure to insulate any field piping all the way to the piping connection inside the unit. Any exposed piping may cause condensation or burns if touched.

Cautions on Pipe Handling

- Protect the open end of the pipe against dust and moisture. (Tighten both edges with clamp.)
- All pipe bends should be as gentle as possible. Use a pipe bender for bending. (Bending radius should be 1-1/4in or larger.)

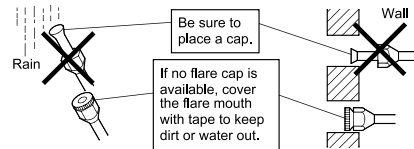

Selection of Copper and Heat Insulation materials

When using commercial copper pipes and fittings, observe the following:

- Insulation material: Polyethylene foam
Heat transfer rate: 0.024 to 0.030Btu/hft°F
Refrigerant gas pipe's surface temperature reaches 230°F max.
Choose heat insulation materials that will withstand this temperature.
- Be sure to insulate both the gas and liquid piping and to provide insulation dimensions as below.

Gas side	Liquid side	Gas pipe thermal insulation	Liquid pipe thermal insulation
O.D. 3/8in	O.D. 1/4in	I.D. 1/2 to 5/8in	I.D. 3/8in

Also, when subject to high humidity, heat insulation of the refrigerant piping (the unit piping and branch piping) must be further reinforced. Reinforce the insulation when installing the unit near bathrooms, kitchens, and other similar locations.

Refer to the following:

- 86°F, more than 75% RH: 13/16in Min. in thickness

If the insulation is not sufficient, condensation may form on the surface of the insulation.

- Use separate thermal insulation pipes for gas and liquid refrigerant pipes.

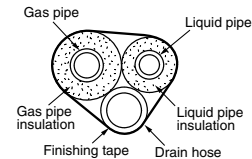

DRAIN PIPING WORK

⚠ Caution

Make sure all water is out before making the duct connection.

■ Install the drain piping.

- Make sure the drain works properly.
- The diameter of the drain pipe should be greater than or equal to the diameter of the connecting pipe (vinyl tube; pipe size: 25/32in; outer dimension: 1-1/32in).
- Keep the drain pipe short and sloping downwards at a gradient of at least 1/100 to prevent air pockets from forming.

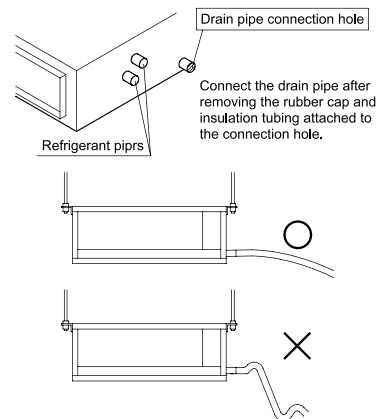

⚠ Caution

Water accumulating in the drain piping can cause the drain to clog.

- To keep the drain tube from sagging, space hanging wires every 3 to 5ft.
- Use the drain hose and the metal clamp. Insert the drain hose fully into the drain socket and firmly tighten the metal clamp with the upper part of the tape on the hose end. Tighten the metal clamp until the screw head is less than 1/8in from the hose.
- The two areas below should be insulated because condensation may form there causing water to leak.
 - Drain piping passing indoors
 - Drain sockets

Referring the figure below, insulate the metal clamp and drain hose using the included large sealing pad.

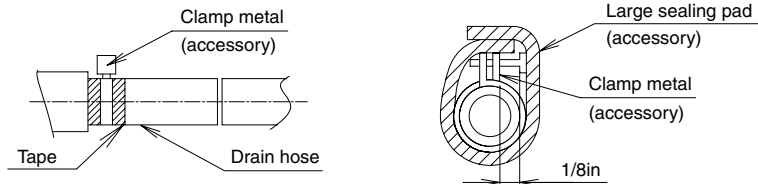

< PRECAUTIONS >

Drain piping connections

- Do not connect the drain piping directly to sewage pipes that smell of ammonia. The ammonia in the sewage might enter the indoor unit through the drain pipes and corrode the heat exchanger.
- Do not twist or bend the drain hose, so that excessive force is not applied to it. (This type of treatment may cause leaking.)

■ After piping work is finished, check drainage flows smoothly.

- Gradually insert approximately 1L of water into the drain pan to check drainage in the manner described below.
 - Gradually pour approximately 1L of water from the outlet hole into the drain pan to check drainage.
 - Check the drainage.

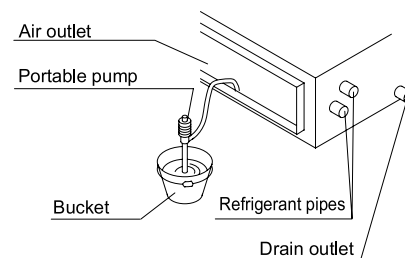

INSTALLING THE DUCT

Connect the duct supplied in the field.

Air inlet side

- Attach the duct and intake-side flange (field supply).
- Connect the flange to the main unit with accessory screws (in 16, 20 or 24 positions).
- Wrap the intake-side flange and duct connection area with aluminum tape or something similar to prevent air escaping.

⚠ Caution

When attaching a duct to the intake side, be sure also to attach an air filter inside the air passage on the intake side. (Use an air filter whose dust collecting efficiency is at least 50% in a gravimetric technique.)

INSTALLING THE DUCT

Outlet side

- Connect the duct according to the inside of the outlet-side flange.
- Wrap the outlet-side flange and the duct connection area with aluminum tape or something similar to prevent air escaping.

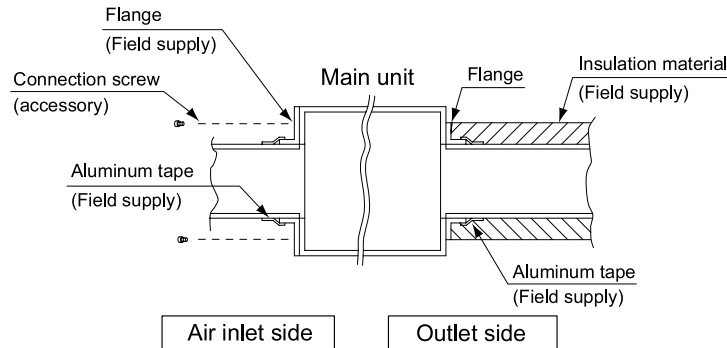

⚠ Caution

- Be sure to insulate the duct to prevent condensation from forming. (Material: glass wool or polyethylene foam, 1in thick)
- Use electric insulation between the duct and the wall when using metal ducts to pass metal laths of the net or fence shape or metal plating into wooden buildings.

WIRING

See the installation manual supplied with the outdoor unit.

■ HOW TO CONNECT WIRINGS.

- Wire only after removing the control box lid as shown in the Fig.

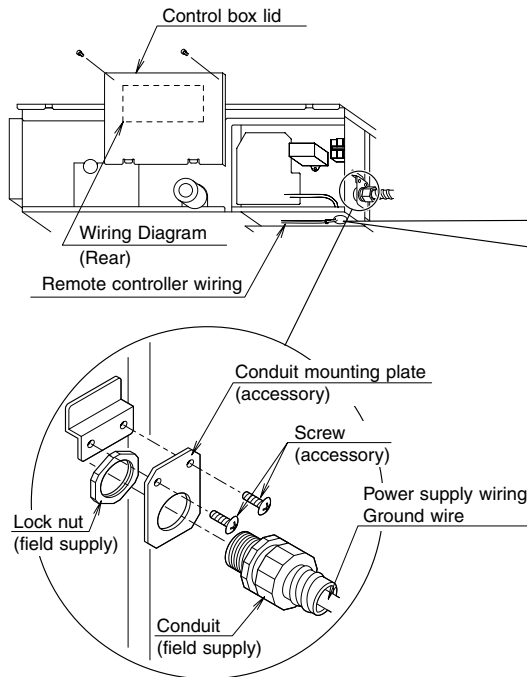

⚠ • Wrap the remote controller wiring with the sealing material as shown in the figure below. (Otherwise, moisture or small creatures such as insects from the outside may cause short-circuit inside the control box.) Attach securely so that there are no gaps.

[How to adhere it]

⚠ Caution

- When doing the wiring, make sure the wiring is neat and does not cause the control box lid to stick up, then close the cover firmly. When attaching the control box lid, make sure you do not pinch any wires.
- Outside the unit, separate the low voltage wiring (remote controller wiring) and high voltage wiring (earth wire and power supply wiring) at least 5in so that they do not pass through the same place together. Proximity may cause electrical interference, malfunctions, and breakage.

[PRECAUTION]

- See also the "Electrical Wiring Diagram Label" when wiring the unit for power supply.

[Connecting electrical wiring]

• Power supply wiring and Earth wire

Remove the control box lid.

Next, pull the wires into the unit through the conduit and thread them through the insulation tube (accessory), then connect to the power wiring terminal block (4P).

Secure the wires covered by the insulation tube with the clamp (accessory).

Be sure to put the part of the sheathed vinyl into the control box.

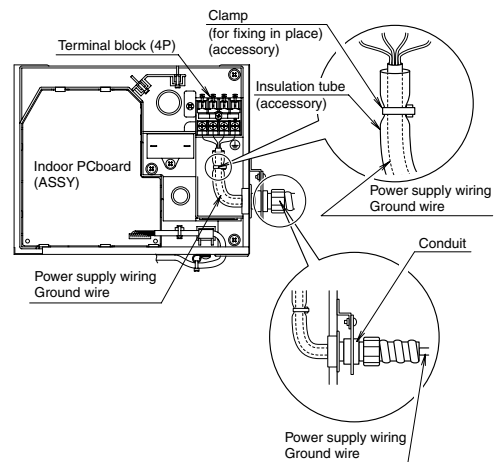

⚠ Warning

Do not use tapped wires, stand wires, extensioncords, or starbust connections, as they may cause overheating, electrical shock, or fire.

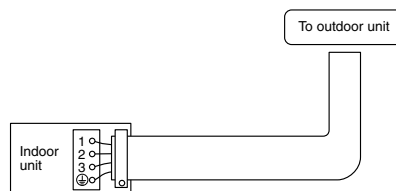

TRIAL OPERATION AND TESTING

Trial operation and testing

- (1) Measure the supply voltage and make sure that it falls in the specified range.
- (2) Trial operation should be carried out in either cooling or heating mode.

<p>Trial operation from remote controller</p> <ol style="list-style-type: none"> (1) Press ON/OFF button to turn on the system. (2) Simultaneously press center of TEMP button and MODE button. (3) Press MODE button twice. ("7" will appear on the display to indicate that Trial Operation mode is selected.) (4) Trial operation mode terminates in approx. 30 minutes and switches into normal mode. To quit the trial operation, press ON/OFF button.

- In cooling mode, select the lowest programmable temperature; in heating mode, select the highest programmable temperature.
- Trial operation may be disabled in either mode depending on the room temperature.
 - After trial operation is complete, set the temperature to a normal level (79°F to 82°F in cooling mode, 68°F to 75°F in heating mode).
 - For protection, the system disables restart operation for 3 minutes after it is turned off.

- (3) Carry out the test operation in accordance with the Operation Manual to ensure that all functions and parts, are working properly.
 - * The air conditioner requires a small amount of power in its standby mode. If the system is not to be used for some time after installation, shut off the circuit breaker to eliminate unnecessary power consumption.
 - * If the circuit breaker trips to shut off the power to the air conditioner, the system will restore the original operation mode when the circuit breaker is turned on again.

Test items



Test items	Symptom (diagnostic display on RC)	Check
Indoor and outdoor units are installed properly on solid bases.	Fall, vibration, noise	
No refrigerant gas leaks.	Incomplete cooling/heating function	
Refrigerant gas and liquid pipes and indoor drain hose extension are thermally insulated.	Water leakage	
Drain pipe is properly installed.	Water leakage	
System is properly grounded.	Electrical leakage	
The specified wires are used for interconnecting wire connections.	Inoperative or burn damage	
Indoor or outdoor unit's air inlet or discharge has clear path of air. Shut-off valves are opened.	Incomplete cooling/heating function	
Indoor unit properly receives remote controller commands.	Inoperative	

12.2 Outdoor Units



12.2.1 Safety Precautions

Safety Precautions

- Read these Safety Precautions carefully to ensure correct installation.
- This manual classifies the precautions into WARNINGS and CAUTIONS. Be sure to follow all the precautions below: they are all important for ensuring safety.



	WARNINGS	Failure to follow any of WARNING is likely to result in such grave consequences as death or serious injury.
	CAUTIONS	Failure to follow any of CAUTION may in some cases result in grave consequences.

- The following safety symbols are used throughout this manual:

	Be sure to observe this instruction.		Be sure to establish a proper earth grounding connection.		Never attempt.
---	--------------------------------------	---	---	---	----------------

- After completing installation, test the unit to check for installation errors. Give the user adequate instructions concerning the use and cleaning of the unit according to the Operation Manual.

WARNINGS

- Installation should be left to the authorized dealer or another trained professional. Improper installation may cause water leakage, electrical shock, fire, or equipment damage.
- Install the air conditioner according to the instructions given in this manual. Incomplete installation may cause water leakage, electrical shock, fire or equipment damage.
- Be sure to use the supplied or exact specified installation parts. Use of other parts may cause the unit to come to lose, water leakage, electrical shock, fire or equipment damage.
- Install the air conditioner on a solid base that is level and can support the unit's weight. An inadequate base or incomplete installation may cause injury or equipment damage in the event the unit falls off the base or comes loose.
- Electrical work should be carried out in accordance with the installation manual and the national, state and local electrical wiring codes. Insufficient capacity or incomplete electrical work may cause electrical shock, fire or equipment damage.
- Be sure to use a dedicated power circuit. Never use a power supply shared by another appliance. Follow all appropriate electrical codes.
- For wiring, use a wire or cable long enough to cover the entire distance with no splices if possible. Do not use an extension cord. Do not put other loads on the power supply. Use a only a separate dedicated power circuit. (Failure to do so may cause abnormal heat, electric shock, fire or equipment damage.)
- Use the specified types of wires for electrical connections between the indoor and outdoor units. Follow all state and local electrical codes. Firmly clamp the interconnecting wires so their terminals receive no external stresses. Incomplete connections or clamping may cause terminal overheating, fire or equipment damage.
- After connecting all wiring be sure to shape the cables so that they do not put undue stress on the electrical covers, panels or terminals. Install covers over the wires. Incomplete cover installation may cause terminal overheating, electrical shock, fire or equipment damage.
- When installing or relocating the system, be sure to keep the refrigerant circuit free from all substances other than the specified refrigerant (R410A), such as air. (Any presence of air or other foreign substance in the refrigerant circuit causes an abnormal pressure rise which may result in rupture, resulting in injury.)
- If any refrigerant has leaked out during the installation work, ventilate the room. (The refrigerant produces a toxic gas if exposed to flames.) 
- After all installation is complete, check to make sure that no refrigerant is leaking. (The refrigerant produces a toxic gas if exposed to flames.) 
- During pump-down, stop the compressor before removing the refrigerant piping. If the compressor is still running and the shut-off valve is open during pump-down, air will be sucked in when the refrigerant piping is removed, causing abnormally high pressure which could lead to equipment damage or and personal injury.
- During installation, attach the refrigerant piping securely before running the compressor. If the compressor is not attached and the shut-off valve is open during pump-down, air will be sucked in when the compressor is run, causing abnormally high pressure which could lead to equipment damage and personal injury.
- Securely install the outdoor unit terminal cover (panel). If the terminal cover (panel) is not installed properly, dust or water may enter the outdoor unit and fire or electric shock may result.
- Install an leak circuit breaker, as required. If an leak circuit breaker is not installed, electric shock may result.
- Be sure to establish a ground. Do not ground the unit to a utility pipe, arrester, or telephone ground. (Incomplete or inadequate grounding may cause equipment damage, or electrical shock, fire and personal injury. A high surge current from lightning or other sources may cause damage to the air conditioner.) 
- Be sure to install a ground fault circuit interrupter breaker. Failure to install a ground fault circuit interrupter breaker may result in electrically shocks, fire or personal injury.

CAUTIONS

- Do not install the air conditioner where gas leakage would be exposed to open flames. If the gas leaks and builds up around the unit, it may catch fire. 
- Establish drain piping according to the instructions of this manual. Inadequate piping may cause water damage.
- Note for installing the outdoor unit. (For heat pump model only.) In regions of the country where the outside temperature is at or below the freezing point, the drain may freeze. If so, it is recommended that an electric heater be installed in order to protect the drain from freezing.
- Tighten the flare nut according to the specified torque. A torque wrench should be used. If the flare nut is tightened too much, the flare nut may crack over time and cause refrigerant leakage.
- Be very careful about product transportation. Some products use PP bands for packaging. Do not use any PP bands for a means of transportation. It is dangerous.
- Never perform outdoor unit piping connection work when it is raining.
- Make sure to provide for adequate measures in order to prevent that the outdoor unit be used as a shelter by small animals. Small animals making contact with electrical parts can cause malfunctions, smoke or fire. Please instruct the customer to keep the area around the unit clean.

12.2.2 RXS09/12DVJU

Accessories

Accessories supplied with the outdoor unit:

(A) Installation manual	1	(B) Drain plug (Heat pump-Models)  Located on the bottom of the packing case.	1
-------------------------	---	--	---

Precautions for Selecting the Location

- 1) Choose a place strong enough to bear the weight and vibration of the unit, The location should not amplified the unit noise.
- 2) Choose a location where the hot air discharged from the unit and the operationing noise will not be a nuisance to the neighbors.
- 3) Avoid noise sensitive locations such as bedrooms to avoid future problems.
- 4) There must be sufficient clearance for carrying the unit into and out of the site.
- 5) There must be sufficient space around the air inlet and the air outlet with no obstructions to airflow.
- 6) The surrounding area must be free from the possibility of flammable gas leakage.
- 7) Install units, power cords and inter-connecting cables at least 10 feet away from television and radio sets. This is to prevent interference to images and sounds. (Noises may be heard even if they are more than 10 feet away depending on radio wave conditions.)
- 8) In coastal areas or other places with salty atmosphere of sulfate gas, corrosion may shorten the life of the air conditioner.
- 9) Do not place moisture sensitive equipment or articles under the outdoor unit condensate drain.

NOTE

Do not install unit by hanging from a ceiling or stacking units.

Caution

When operating the air conditioner in a outdoor temperature below, be sure to follow the instructions described below.

- 1) To prevent exposure to wind, install the outdoor unit with its suction side facing the wall.
- 2) Never install the outdoor unit at a site where the suction side may be exposed directly to wind.
- 3) To prevent exposure to wind, it is recommended to install a baffle plate on the air discharge side of the outdoor unit.
- 4) In heavy snowfall areas, select an installation site where the snow will not affect the unit.

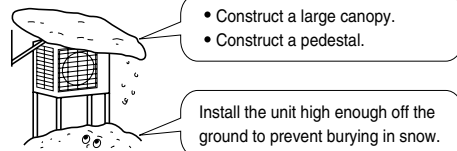

Precautions on Installation

- Ensure the strength and level of the installation will not cause any operating vibration or noise after installed.
- In accordance with the foundation drawing, fix the unit securely by means of the foundation bolts. (Prepare four sets of 3/8" or 7/16" foundation bolts, nuts and washers each which are available on the market.)
- It is best to screw in the foundation bolts until their length are 3/4" from the foundation surface.

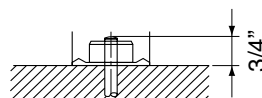

Outdoor Unit Installation Drawings

Model	09 / 12 class
Max. allowable length	65 ft
Max. allowable height	49 ft
Additional refrigerant required for refrigerant pipe exceeding 33 ft in length.	0.22 oz/ft
Gas pipe	O.D. 3/8"
Liquid pipe	O.D. 1/4"

* Be sure to add the proper amount of additional refrigerant. Failure to do so may result in reduced performance.

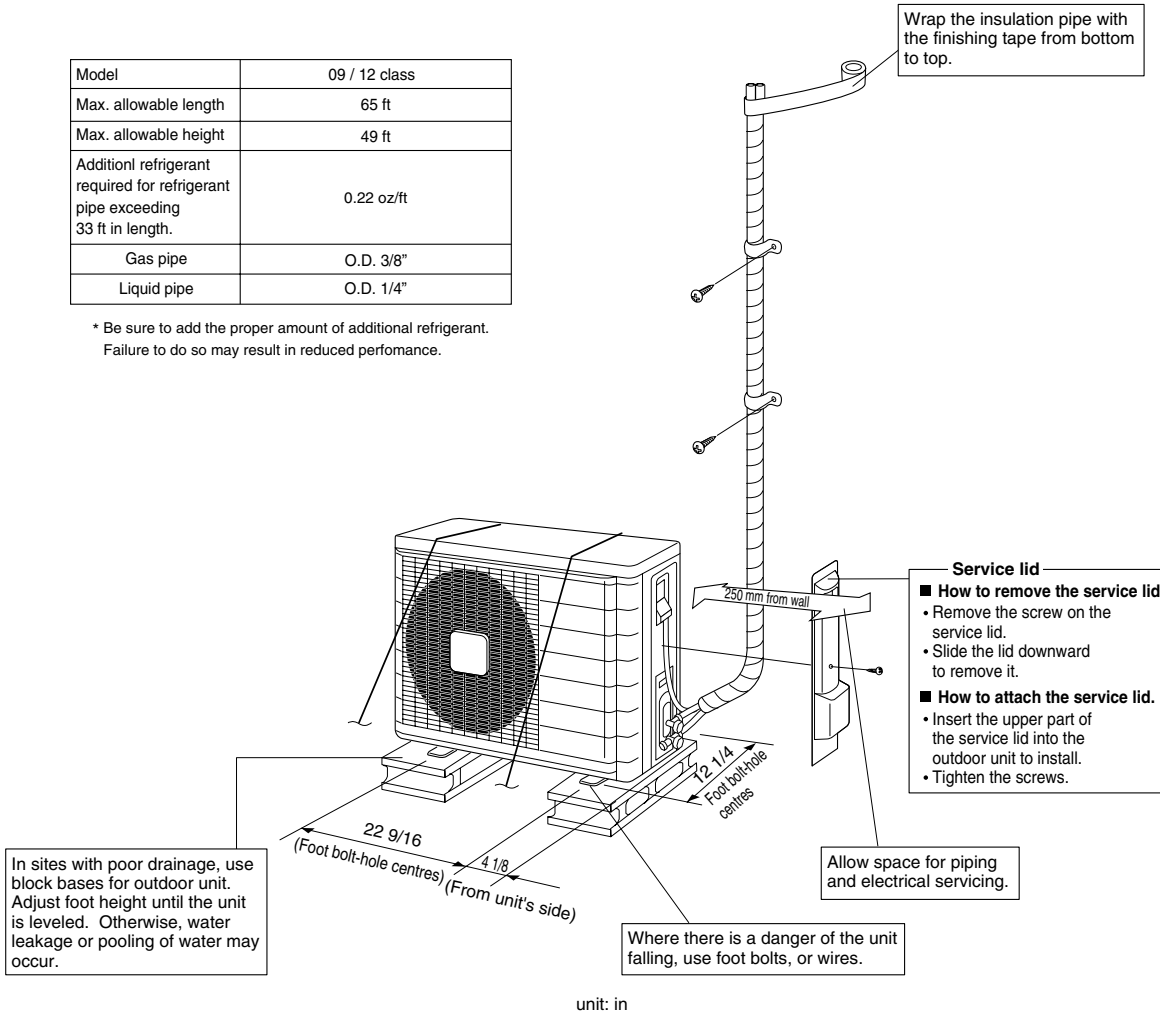

Installation Guidelines

- Where a wall or other obstacle is in the path of outdoor unit's intake or exhaust airflow, follow the installation guidelines below.
- For any of the below installation patterns, the wall height on the exhaust side should be 4 ft or less.

Wall facing one side

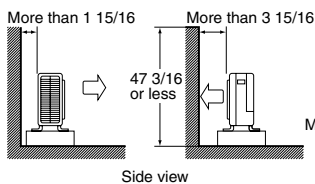

Walls facing two sides

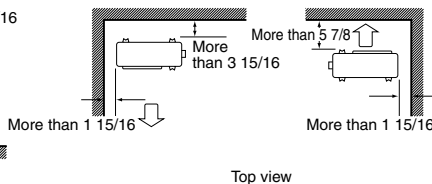

Walls facing three sides

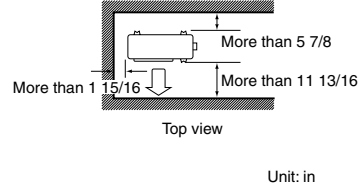

Unit: in

Outdoor Unit Installation

1. Installing Outdoor Unit

- 1) When installing the outdoor unit, refer to "Precautions for Selecting the Location" and the "Outdoor Unit Installation Drawings".
- 2) If drain work is necessary, follow the procedures below.

2. Drain Work (Heat pump-Models)

- 1) Use drain plug for drainage.
- 2) If the drain port is covered by a mounting base or floor surface, place additional foot bases of at least 1 1/4" in height under the outdoor unit's feet.
- 3) In cold areas, do not use a drain hose with the outdoor unit.
(Otherwise, drain water may freeze, impairing heating performance.)

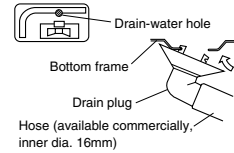

3. Flaring the Pipe End

- 1) Cut the pipe end with a pipe cutter.
- 2) Remove burrs with the cut surface facing downward so that the chips do not enter the pipe.
- 3) Put the flare nut on the pipe.
- 4) Flare the pipe.
- 5) Check that the flaring is properly made.



Flaring

Set exactly at the position shown below.

Die	Flare tool for R410A		Conventional flare tool	
	Clutch-type	Clutch-type (Rigid-type)	Clutch-type	Wing-nut type (Imperial-type)
A	0 ~ 0.020"	0.039 ~ 0.059"	0.059 ~ 0.079"	

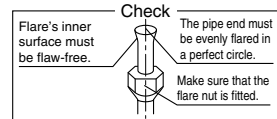

⚠ Warning

- 1) Do not use mineral oil on flared part.
- 2) Prevent mineral oil from getting into the system as this would reduce the unit life.
- 3) Never use piping which has been used for previous installations. Only use parts which are provided with the unit.
- 4) Do never install a refrigerant drier to this unit.
- 5) The drying material may dissolve and damage the system.
- 6) Incomplete or improper flaring may cause refrigerant gas leakage.

4. Refrigerant Piping

- 1) Align the centers of both flares and tighten the flare nuts 3 or 4 turns by hand. Then tighten them fully with the torque wrenches.
 - Use torque wrenches when tightening the flare nuts to prevent damage to the flare nuts and escaping gas.
- 2) To prevent gas leakage, apply refrigeration machine oil on both inner and outer surfaces of the flare. (Use refrigeration oil for R410A)

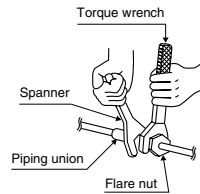
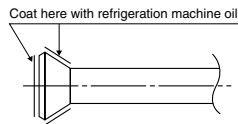

Flare nut tightening torque		Valve cap tightening torque	
Gas side	Liquid side	Gas side	Liquid side
3/8 inch	1/4 inch	3/8 inch	1/4 inch
24.1~29.4ft • lbf	10.4~12.7ft • lbf	15.9~20.2ft • lbf	15.9~20.2ft • lbf
		Service port cap tightening torque	7.9~10.8ft • lbf

Outdoor Unit Installation

5. Purging Air and Checking for Gas Leakage

- When the piping work is completed, it is necessary to purge the air and check for gas leakage.

Warning

- Do not place any substance other than the specified refrigerant (R410A) into the refrigeration cycle.
- When a refrigerant gas leak occurs, ventilate the room as soon and as much as possible.
- R410A, as well as other refrigerants, should always be recovered and never be released directly into the environment.
- Use a vacuum pump for R410A exclusively. Using the same vacuum pump for different refrigerants may damage the vacuum pump or the unit.

- If adding additional refrigerant, perform air purging from the refrigerant pipes and indoor unit using a vacuum pump before charging additional refrigerant.
- Use a hexagonal wrench (3/16") to operate the shut-off valve rod.
- All refrigerant pipe joints should be tightened with a torque wrench to the specified tightening torque.

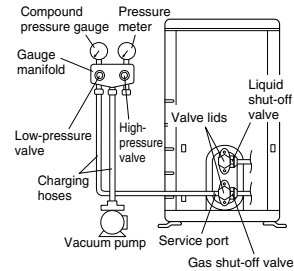

1) Connect projection side (on which worm pin is pressed) of charging hose (which comes from gauge manifold) to gas shut-off valve's service port.



2) Fully open gauge manifold's low-pressure valve (Lo) and completely close its high-pressure valve (Hi). (High-pressure valve subsequently requires no operation.)



3) Do vacuum pumping and make sure that the vacuum pressure gauge reads -29.9 inHg *1.



4) Close gauge manifold's low-pressure valve (Lo) and stop vacuum pump. (Keep this state for a few minutes to make sure that the vacuum pressure gauge pointer does not swing back.)*2.



5) Remove covers from liquid shut-off valve and gas shut-off valve.



6) Turn the liquid shut-off valve's rod 90 degrees counterclockwise with a hexagonal wrench to open valve. Close it after 5 seconds, and check for gas leakage. Using soapy water, check for gas leakage from indoor unit's flare and outdoor unit's flare and valve rods. After the check is complete, wipe all soapy water off.



7) Disconnect charging hose from gas shut-off valve's service port, then fully open liquid and gas shut-off valves. (Do not attempt to turn valve rod beyond its stop.)



8) Tighten valve lids and service port caps for the liquid and gas shut-off valves with a torque wrench at the specified torques.

*1. Pipe length vs. vacuum pump run time

Pipe length	Up to 50 feet	More than 50 feet
Run time	Not less than 10 min.	Not less than 15 min.

*2. If the vacuum pressure gauge pointer swings back, refrigerant may have water content or a loose pipe joint may exist. Check all pipe joints and retighten nuts as needed, then repeat steps 2) through 4).

6. Refilling The Refrigerant

Check the type of refrigerant to be used on the machine nameplate.

Precautions when adding R410A

Fill from the liquid pipe in liquid form.

It is a mixture of refrigerant, so adding it in gas form may cause the refrigerant composition to change, preventing normal operation.

- 1) Before filling, check whether the cylinder has a siphon attached or not. (It should have something like "liquid filling siphon attached" displayed on it.)

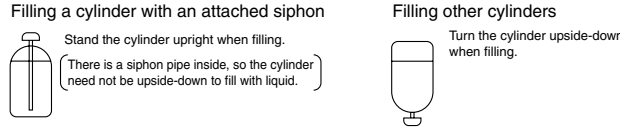

- Be sure to use the R410A tools to ensure pressure and to prevent foreign objects entering.

7. Refrigerant Piping Work

7-1 Cautions on Pipe Handling

- 1) Protect the open end of the pipe against dust and moisture.
- 2) All pipe bends should be as gentle as possible. Use a pipe bender for bending. (Bending radius should be 1 1/4" to 1 5/8" mm or larger.)

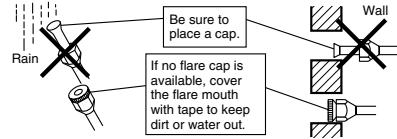

7-2 Selection of Copper and Heat Insulation materials

When using commercial copper pipes and fittings, observe the following:

- 1) Insulation material: Polyethylene foam
Heat transfer rate: 0.041 to 0.052 kW/mK (0.024-0.030 Btu/ft²°F)
Refrigerant gas pipe's surface temperature reaches 230°F max.
Choose heat insulation materials that will withstand this temperature.
- 2) Be sure to insulate both the gas and liquid piping and to provide insulation dimensions as below.

Gas side	Liquid side	Gas pipe thermal insulation	Liquid pipe thermal insulation
09/12 class		09/12 class	
O.D. 3/8 in	O.D. 1/4 in	I.D. 0.472-0.590 in	I.D. 0.315-0.393 in
Thickness 0.031 in		Thickness 0.393 in Min.	

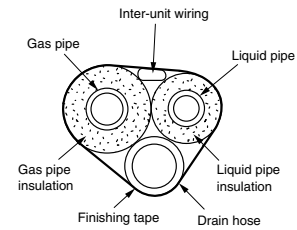

- 3) Use separate thermal insulation pipes for gas and liquid refrigerant pipes.

Pump Down Operation

In order to protect the environment, be sure to pump down when relocating or disposing of the unit.

- 1) Remove the valve lid from liquid shut-off valve and gas shut-off valve.
- 2) Carry out forced cooling operation.
- 3) After five to ten minutes, close the liquid shut-off valve with a hexagonal wrench.
- 4) After two to three minutes, close the gas shut-off valve and stop forced cooling operation.

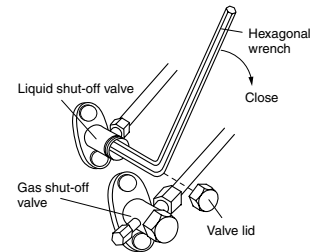

How to force cooling operation mode

■ Using the indoor unit operation/stop button

Press the indoor unit operation/stop button for at least five seconds. (Operation will start.)

- Forced cooling operation will stop automatically after around 15 minutes.
To force a test run to stop, press the indoor unit operation/stop button.

■ Using the main unit's remote control

- 1) Press the "operation/stop" button. (Operation will start.)
 - 2) Press the temperature ▲▼ button and the "operation select" button at the same time.
 - 3) Press the "operation select" button twice. (T will be displayed and the unit will enter test run mode.)
 - 4) Press the "operation select" button to return the operation mode to cooling.
- Test run mode will stop automatically after around 30 minutes. To force a test run to stop, press the operation/stop button.

⚠ Caution

After closing the liquid shut-off valve, close the gas shut-off valve within three minutes, then stop the forced operation.

Wiring

Warning

- 1) Do not use spliced wires, stand wires, extension cords, or starburst connections, as they may cause overheating, electrical shock, or fire. Follow all Local, and State electrical codes.
- 2) Do not use locally purchased electrical parts inside the product. (Do not overload the circuit by adding drain pump or other electrical equipment to unit terminals.) Doing so may cause electric shock or fire.
- 3) Be sure to install an earth leak detector. (One that can handle higher harmonics.)
(This unit uses an inverter, which means that it must be used an earth leak detector capable handling harmonics in order to prevent malfunctioning of the earth leak detector itself.)
- 4) When carrying out wiring connection, take care not to pull at the conduit.

Do not turn ON the safety breaker until all work is completed.

- 1) Strip the insulation from the wire (3/4 in).
- 2) Connect the connection wires between the indoor and outdoor units **so that the terminal numbers match**. Tighten the terminal screws securely. We recommend a flathead screwdriver be used to tighten the screws.
The screws are packed with the terminal board.

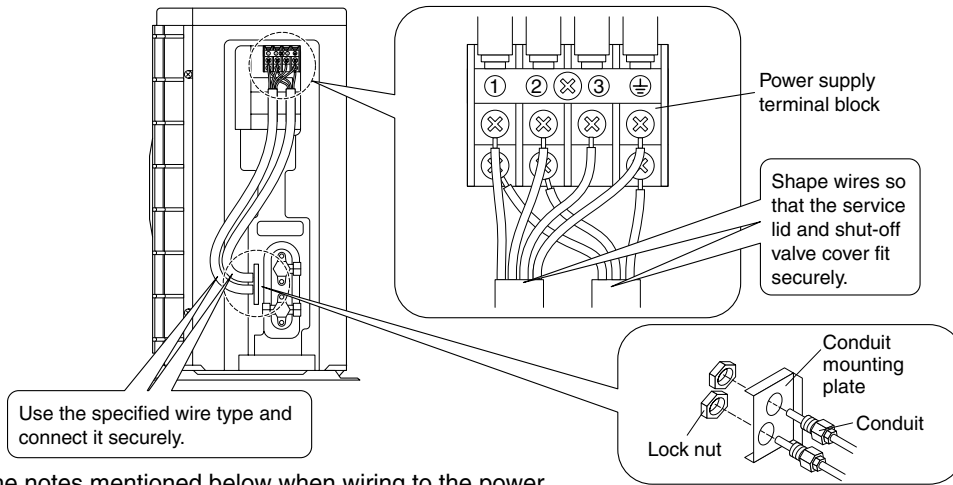
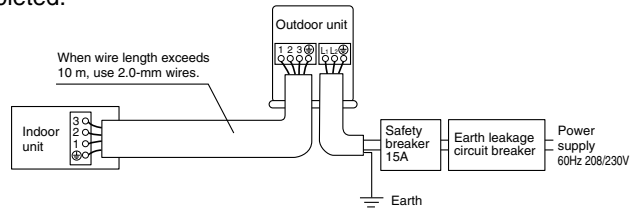

Observe the notes mentioned below when wiring to the power supply terminal board.

Precautions to be taken for power supply wiring.

(Use a round crimp-style terminal for connection to the power supply terminal board. In case it cannot be used due to unavoidable reasons, be sure to observe the following instruction.)

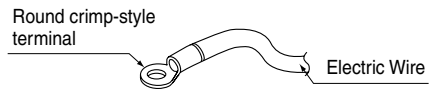

Caution

When connecting the connection wires to the terminal board using a single core wire, be sure to perform curling. Problems with the work may cause heat and fires.

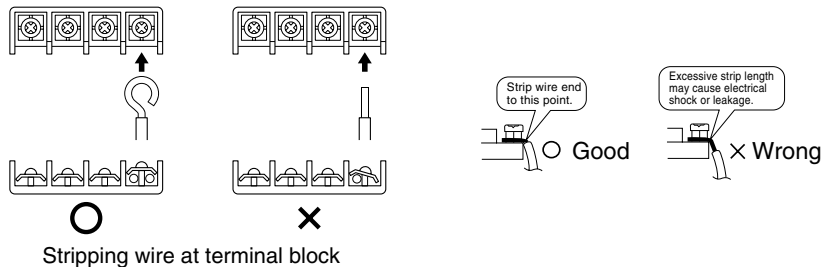

- 3) Pull the wire and make sure that it is tight. Then fix the wire in place with a strain relief.

Run Test and Final Check

1. Trial Operation and Testing.

1-1 Measure the supply voltage and make sure that it falls in the specified range.

1-2 Trial operation should be carried out in either cooling or heating mode.

- In cooling mode, select the lowest programmable temperature; in heating mode, select the highest programmable temperature.
 - 1) Trial operation may be disabled in either mode depending on the room temperature.
 - 2) After trial operation is complete, set the temperature to a normal level (78°F to 82°F in cooling mode, 68°F to 75°F in heating mode).
 - 3) For protection, the unit disables restart operation for 3 minutes after it is turned off.

1-3 Carry out the test operation in accordance with the Operation Manual to ensure that all functions and parts, such as louver movement, are working properly.

- The air conditioner requires a small amount of power in its standby mode. If the system is not to be used for some time after installation, shut off the circuit breaker to eliminate unnecessary power consumption.
- If the circuit breaker trips to shut off the power to the air conditioner, the system will restore the original operation mode when the circuit breaker is opened again.

2. Test Items.

Test Items	Symptom (diagnostic display on RC)	Check
Indoor and outdoor units are installed properly on solid bases.	Fall, vibration, noise	
No refrigerant gas leaks.	Incomplete cooling/heating function	
Refrigerant gas and liquid pipes and indoor drain hose extension are thermally insulated.	Water leakage	
Drain line is properly installed.	Water leakage	
System is properly ground to earth.	Electrical leakage	
The specified wires are used for interconnecting wire connections.	Inoperative or burn damage	
Indoor or outdoor unit's air intake or exhaust has clear path of air. Shut-off valves are opened.	Incomplete cooling/heating function	
Indoor unit properly receives remote control commands.	Inoperative	

12.2.3 RXS15/18/24DVJU

Accessories

Accessories supplied with the outdoor unit:

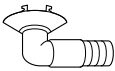
(A) Installation manuals	1	(B) Drain plug (Heat pump-Models)  Located on the bottom of the packing case.	1
--------------------------	---	---	---

Precautions for Selecting the Location

- 1) Choose a place strong enough to bear the weight and vibration of the unit, The location should not amplified the unit noise.
- 2) Choose a location where the hot air discharged from the unit and the operating noise will not be a nuisance to the neighbors.
- 3) Avoid noise sensitive locations such as bedrooms to avoid future problems.
- 4) There must be sufficient clearance for carrying the unit into and out of the site.
- 5) There must be sufficient space around the air inlet and the air outlet with no obstructions to airflow.
- 6) The surrounding area must be free from the possibility of flammable gas leakage.
- 7) Install units, power cords and inter-connecting cables at least 10 feet away from television and radio sets. This is to prevent interference to images and sounds. (Noises may be heard even if they are more than 10 feet away depending on radio wave conditions.)
- 8) In coastal areas or other places with salty atmosphere of sulfate gas, corrosion may shorten the life of the air conditioner.
- 9) Do not place moisture sensitive equipment or articles under the outdoor unit condensate drain.

NOTE

Do not install unit by hanging from a ceiling or stacking units.

Caution

When operating the air conditioner in an outdoor temperature below, be sure to follow the instructions described below.

- 1) To prevent exposure to wind, install the outdoor unit with its suction side facing the wall.
- 2) Never install the outdoor unit at a site where the suction side may be exposed directly to wind.
- 3) To prevent exposure to wind, it is recommended to install a baffle plate on the air discharge side of the outdoor unit.
- 4) In heavy snowfall areas, select an installation site where the snow will not affect the unit.

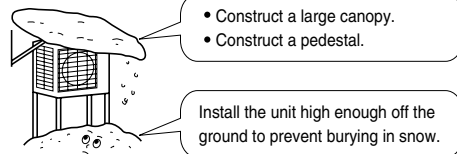

Precautions on Installation

- Ensure the strength and level of the installation will not cause any operating vibration or noise after installed.
- In accordance with the foundation drawing, fix the unit securely by means of the foundation bolts. (Prepare four sets of 3/8" or 7/16" foundation bolts, nuts and washers each which are available on the market.)
- It is best to screw in the foundation bolts until their length are 3/4" from the foundation surface.

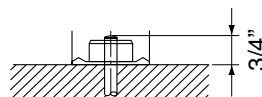

Outdoor Unit Installation Drawings

Model	15 class	18 class	24 class
Max. allowable length	98.4 ft		
Min. allowable length	4.9 ft		
Max. allowable height	65.6 ft		
Additional refrigerant required for refrigerant pipe exceeding 33 ft in length.	0.22 oz/ft		
Gas pipe	O.D. 1/2"	O.D. 5/8"	
Liquid pipe	O.D. 1/4"		

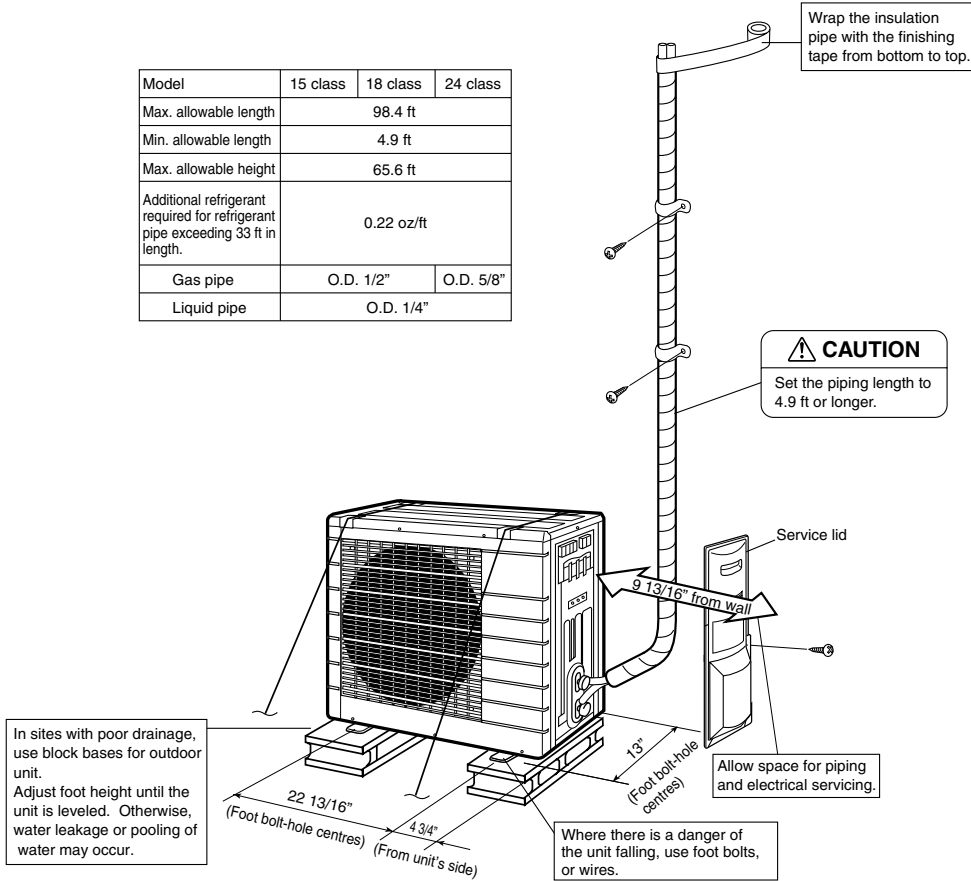

Installation Guidelines

- Where a wall or other obstacle is in the path of outdoor unit's intake or exhaust airflow, follow the installation guidelines below.
- For any of the below installation patterns, the wall height on the exhaust side should be 4 ft or less.

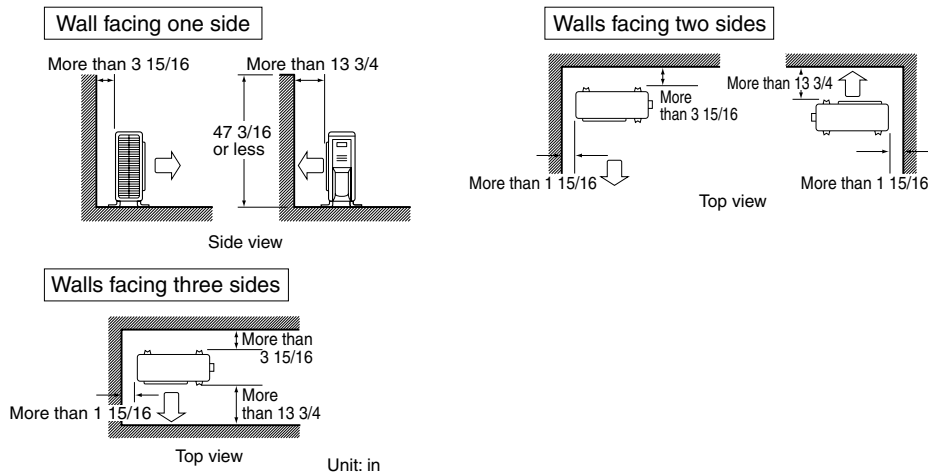

Outdoor Unit Installation

1. Installing Outdoor Unit

- 1) When installing the outdoor unit, refer to "Precautions for Selecting the Location" and the "Outdoor Unit Installation Drawings."
- 2) If drain work is necessary, follow the procedures below.

2. Drain Work

- 1) Use drain plug for drainage.
- 2) If the drain port is covered by a mounting base or floor surface, place additional foot bases of at least 1 1/4" in height under the outdoor unit's feet.
- 3) In cold areas, do not use a drain hose with the outdoor unit. (Otherwise, drain water may freeze, impairing heating performance.)

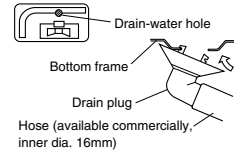

3. Flaring the Pipe End

- 1) Cut the pipe end with a pipe cutter.
- 2) Remove burrs with the cut surface facing downward so that the chips do not enter the pipe.
- 3) Put the flare nut on the pipe.
- 4) Flare the pipe.
- 5) Check that the flaring is properly made.

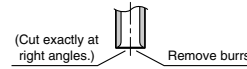

Flaring

Set exactly at the position shown below.

Die	Flare tool for R-410A		Conventional flare tool	
	Clutch-type	Clutch-type (Rigid-type)	Wing-nut type (Imperial-type)	
A	0 - 0.020"	0.039 - 0.059"	0.059 - 0.079"	

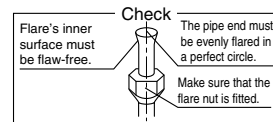

Warning

- 1) Do not use mineral oil on flared part.
- 2) Prevent mineral oil from getting into the system as this would reduce the unit life.
- 3) Never use piping which has been used for previous installations. Only use parts which are provided with the unit.
- 4) Do never install a refrigerant drier to this unit.
- 5) The drying material may dissolve and damage the system.
- 6) Incomplete or improper flaring may cause refrigerant gas leakage.

4. Refrigerant Piping

- 1) Align the centers of both flares and tighten the flare nuts 3 or 4 turns by hand. Then tighten them fully with the torque wrenches.
 - Use torque wrenches when tightening the flare nuts to prevent damage to the flare nuts and escaping gas.
- 2) To prevent gas leakage, apply refrigeration machine oil on both inner and outer surfaces of the flare. (Use refrigeration oil for R410A)

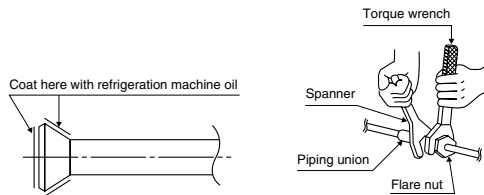

Flare nut tightening torque		
Gas side		Liquid side
1/2 inch	5/8 inch	1/4 inch
36.5~44.5ft • lbf	45.6~55.6ft • lbf	10.4~12.7ft • lbf

Valve cap tightening torque		
Gas side		Liquid side
1/2 inch	5/8 inch	1/4 inch
35.5~44.0ft • lbf	32.5~39.7ft • lbf	15.9~20.2ft • lbf

Service port cap tightening torque	7.9~10.8ft • lbf
------------------------------------	------------------

Outdoor Unit Installation

5. Purging Air and Checking for Gas Leakage

- When the piping work is completed, it is necessary to purge the air and check for gas leakage.

⚠ Warning

- Do not place any substance other than the specified refrigerant (R410A) into the refrigeration cycle.
- When a refrigerant gas leak occurs, ventilate the room as soon and as much as possible.
- R410A, as well as other refrigerants, should always be recovered and never be released directly into the environment.
- Use a vacuum pump for R410A exclusively. Using the same vacuum pump for different refrigerants may damage the vacuum pump or the unit.

- If adding additional refrigerant, perform air purging from the refrigerant pipes and indoor unit using a vacuum pump before charging additional refrigerant.
- Use a hexagonal wrench (3/16") to operate the shut-off valve rod.
- All refrigerant pipe joints should be tightened with a torque wrench to the specified tightening torque.

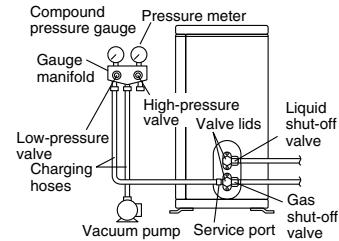

1) Connect projection side (on which worm pin is pressed) of charging hose (which comes from gauge manifold) to gas shut-off valve's service port.



2) Fully open gauge manifold's low-pressure valve (Lo) and completely close its high-pressure valve (Hi). (High-pressure valve subsequently requires no operation.)



3) Do vacuum pumping and make sure that the vacuum pressure gauge reads - 29.9 inHg *1.



4) Close gauge manifold's low-pressure valve (Lo) and stop vacuum pump. (Keep this state for a few minutes to make sure that the vacuum pressure gauge pointer does not swing back.)*2.



5) Remove valve lids from liquid shut-off valve and gas shut-off valve.



6) Turn the liquid shut-off valve's rod 90 degrees counterclockwise with a hexagonal wrench to open valve. Close it after 5 seconds, and check for gas leakage. Using soapy water, check for gas leakage from indoor unit's flare and outdoor unit's flare and valve rods. After the check is complete, wipe all soapy water off.



7) Disconnect charging hose from gas shut-off valve's service port, then fully open liquid and gas shut-off valves. (Do not attempt to turn valve rod beyond its stop.)



8) Tighten valve lids and service port cap for the liquid and gas shut-off valves with a torque wrench at the specified torques.

*1. Pipe length vs. vacuum pump run time

Pipe length	Up to 50 feet	More than 50 feet
Run time	Not less than 10 min.	Not less than 15 min.

*2. If the vacuum pressure gauge pointer swings back, refrigerant may have water content or a loose pipe joint may exist. Check all pipe joints and retighten nuts as needed, then repeat steps 2) through 4).

6. Refilling The Refrigerant

Check the type of refrigerant to be used on the machine nameplate.

Precautions when adding R410A

Fill from the liquid pipe in liquid form.

It is a mixture of refrigerant, so adding it in gas form may cause the refrigerant composition to change, preventing normal operation.

- 1) Before filling, check whether the cylinder has a siphon attached or not. (It should have something like "liquid filling siphon attached" displayed on it.)

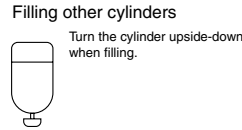
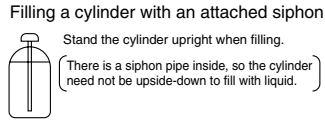

- Be sure to use the R410A tools to ensure pressure and to prevent foreign objects entering.

7. Refrigerant Piping Work

7-1 Cautions on Pipe Handling

- 1) Protect the open end of the pipe against dust and moisture.
- 2) All pipe bends should be as gentle as possible. Use a pipe bender for bending. (Bending radius should be 1 1/4" to 1 5/8" or larger.)

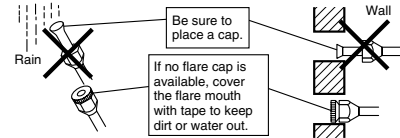

7-2 Selection of Copper and Heat Insulation materials

When using commercial copper pipes and fittings, observe the following:

- 1) Insulation material: Polyethylene foam
Heat transfer rate: 0.041 to 0.052 kW/mK (0.024-0.030 Btu/ft²°F)
Refrigerant gas pipe's surface temperature reaches 230°F max.
Choose heat insulation materials that will withstand this temperature.
- 2) Be sure to insulate both the gas and liquid piping and to provide insulation dimensions as below.

Gas side		Liquid side	Gas pipe thermal insulation		Liquid pipe thermal insulation
15/18 class	24 class	15/18/24 class	15/18 class	24 class	15/18/24 class
O.D. 1/2 in	O.D. 5/8 in	O.D. 1/4 in	I.D. 0.551-0.630 in	I.D. 0.630-0.709 in	I.D. 0.315-0.393 in
Thickness 0.031 in	Thickness 0.039 in	Thickness 0.031 in	Thickness 0.393 in Min.		

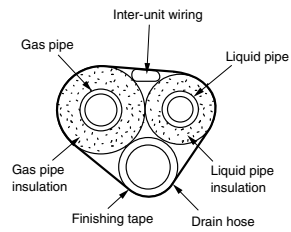

- Use separate thermal insulation pipes for gas and liquid refrigerant pipes.

Pump Down Operation

In order to protect the environment, be sure to pump down when relocating or disposing of the unit.

- 1) Remove the valve lids from liquid shut-off valve and gas shut-off valve.
- 2) Carry out forced cooling operation.
- 3) After five to ten minutes, close the liquid shut-off valve with a hexagonal wrench.
- 4) After two to three minutes, close the gas shut-off valve and stop forced cooling operation.

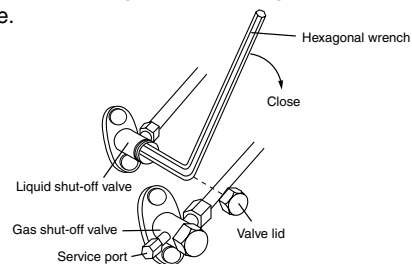

Forced cooling operation

- 1) Press the Forced Operation switch (SW1) to begin forced cooling. Press the Forced Operation switch (SW1) again to stop forced cooling.

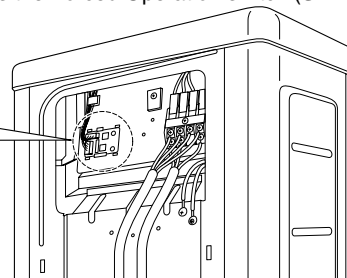
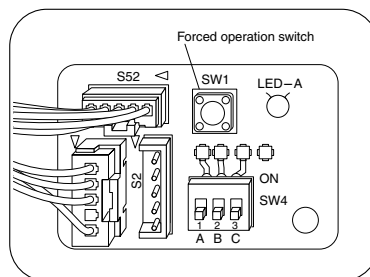

Wiring

⚠ Warning

- 1) Do not use spliced wires, stand wires, extension cords, or starburst connections, as they may cause overheating, electrical shock, or fire. Follow all Local, and State electrical codes.
- 2) Do not use locally purchased electrical parts inside the product. (Do not overload the circuit by adding drain pump or other electrical equipment to unit terminals.) Doing so may cause electric shock or fire.
- 3) Be sure to install an earth leak detector. (One that can handle higher harmonics.)
(This unit uses an inverter, which means that it must be used an earth leak detector capable handling harmonics in order to prevent malfunctioning of the earth leak detector itself.)
- 4) When carrying out wiring connection, take care not to pull at the conduit.

Do not turn ON the safety breaker until all work is completed.

- 1) Strip the insulation from the wire (3/4 in).
- 2) Connect the connection wires between the indoor and outdoor units **so that the terminal numbers match**. Tighten the terminal screws securely. We recommend a flathead screwdriver be used to tighten the screws.
The screws are packed with the terminal board.

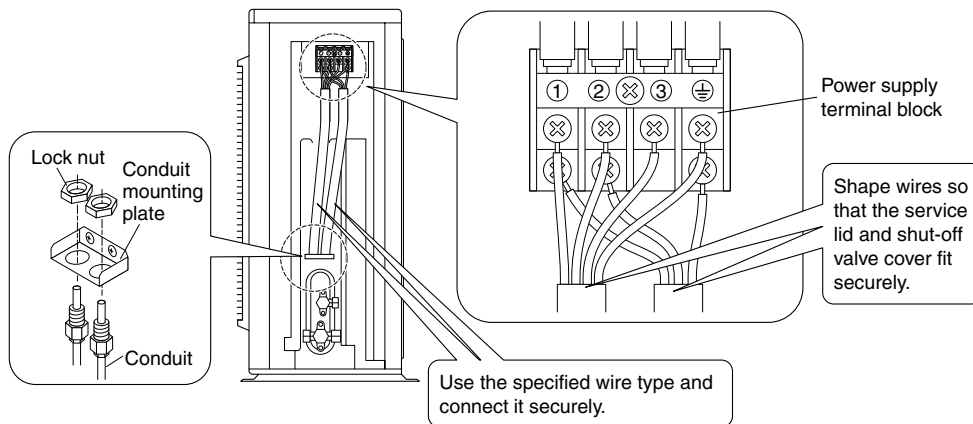
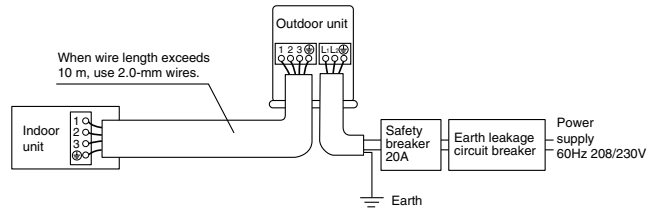

Observe the notes mentioned below when wiring to the power supply terminal board.

Precautions to be taken for power supply wiring.
(Use a round crimp-style terminal for connection to the power supply terminal board. In case it cannot be used due to unavoidable reasons, be sure to observe the following instruction.)

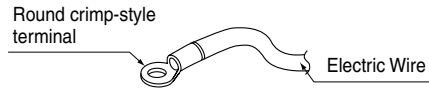

⚠ Caution

When connecting the connection wires to the terminal board using a single core wire, be sure to perform curling. Problems with the work may cause heat and fires.

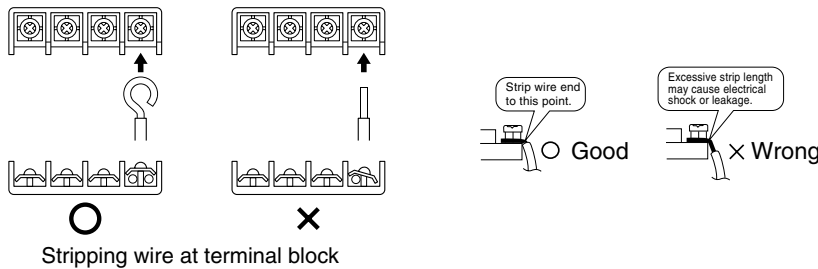

- 3) Pull the wire and make sure that it is tight. Then fix the wire in place with a strain relief.

Run Test and Final Check

1. Trial Operation and Testing.

1-1 Measure the supply voltage and make sure that it falls in the specified range.

1-2 Trial operation should be carried out in either cooling or heating mode.

- In cooling mode, select the lowest programmable temperature; in heating mode, select the highest programmable temperature.
 - 1) Trial operation may be disabled in either mode depending on the room temperature.
 - 2) After trial operation is complete, set the temperature to a normal level (78°F to 82°F in cooling mode, 68°F to 75°F in heating mode).
 - 3) For protection, the unit disables restart operation for 3 minutes after it is turned off.

1-3 Carry out the test operation in accordance with the Operation Manual to ensure that all functions and parts, are working properly.

- The air conditioner requires a small amount of power in its standby mode. If the system is not to be used for some time after installation, shut off the circuit breaker to eliminate unnecessary power consumption.
- If the circuit breaker trips to shut off the power to the air conditioner, the system will restore the original operation mode when the circuit breaker is opened again.

2. Test Items.

Test Items	Symptom	Check
Indoor and outdoor units are installed properly on solid bases.	Fall, vibration, noise	
No refrigerant gas leaks.	Incomplete cooling/heating function	
Refrigerant gas and liquid pipes and indoor drain hose extension are thermally insulated.	Water leakage	
Drain line is properly installed.	Water leakage	
System is properly ground to earth.	Electrical leakage	
The specified wires are used for interconnecting wire connections.	Inoperative or burn damage	
Indoor or outdoor unit's air intake or exhaust has clear path of air. Shut-off valves are opened.	Incomplete cooling/heating function	
Indoor unit properly receives remote control commands.	Inoperative	

13. Operation Manual

13.1 Safety Precautions

Safety precautions

- Keep this manual where the operator can easily find it.
- Read this manual carefully before starting the unit.
- For safety reason, the operator must read the following cautions carefully.
- This manual classifies precautions into DANGER, WARNING and CAUTION. Be sure to follow all precautions below: they are all important for ensuring safety.

 DANGER	 WARNING	 CAUTION
Indicates an imminently hazardous situation which, if not avoided, will result in death or serious injury.	If you do not follow these instructions exactly, the unit may cause property damage, personal injury or loss of life.	If you do not follow these instructions exactly, the unit may cause minor or moderate property damage or personal injury.

 Never do.

 Be sure to ground the air conditioner.

 Never touch the air conditioner (including the remote controller) with a wet hand.



 Be sure to follow the instructions.

 Never cause the air conditioner (including the remote controller) to get wet.

DANGER

- For refrigerant leakage, consult your dealer. Refrigerant gas is heavier than air and replaces oxygen. A massive leak could lead to oxygen depletion, especially in basements, and an asphyxiation hazard could occur leading to serious injury or death.
- Refrigerant gas may produce a toxic gas if it comes in contact with fire such as from a fan heater, stove or cooking device. Exposure to this gas could cause severe injury or death.
- Any abnormalities in the operation of the air conditioner such as smoke or fire could result in severe injury or death. Turn off the power and contact your dealer immediately for instructions.
- Do not install the unit in an area where flammable materials are present due to risk of explosion resulting in serious injury or death.
- If equipment utilizing a burner is used in the same room as the air conditioner, there is the danger of oxygen deficiency which could lead to an asphyxiation hazard resulting in serious injury or death. Be sure to ventilate the room sufficiently to avoid this hazard.
- Safely dispose of the packing materials. Packing materials, such as nails and other metal or wooden parts, may cause stabs or other injuries. Tear apart and throw away plastic packaging bags so that children will not play with them. Children playing with plastic bags face the danger of death by suffocation.

WARNING

- It is not good for health to expose your body to the air flow for a long time.
- Do not put your finger, a rod or other objects into the air outlet or inlet. As the fan is rotating at a high speed and could, cause injury. Always keep small children away from the unit during operation. 
- Do not attempt to repair, relocate, modify or reinstall the air conditioner by yourself. Incorrect work or modifications could cause electric shocks, fire or other damage. For repairs and reinstallation, consult your Daikin dealer for advice and information.
- If the air conditioner is not cooling (heating) properly, the refrigerant may be leaking, contact your authorized dealer or qualified service repairman. When making repairs which requires adding refrigerant, consult with your authorized dealer or qualified service repairman. 
- Do not attempt to install the air conditioner by yourself. Improper installation could result in water leakage, electric shocks or fire. For installation, consult your authorized dealer or a qualified technician.

⚠ CAUTION

- The air conditioner must be grounded to the earth. Improper grounding may result in electric shocks. Do not connect the earth grounding wire to a gas pipe, water pipe, lightning rod, or a telephone ground line. Follow all local and state electrical codes. 

- Do not use this unit for cooling precision instruments, food, plants, animals or works of art. 
- Never expose little children, plants or animals directly to the air flow.
- Do not block air inlets nor outlets. Impaired air flow may result in poor performance or equipment problems.
- Do not stand, sit, or place objects on the outdoor unit. To avoid injury, do not remove the fan guard.
- Do not place anything under the indoor or outdoor unit that must be kept away from moisture, such as electrical or electronic equipment. In certain conditions, moisture in the air may condense and drip.
- Check the unit stand and fittings for damage annually.
- Do not touch the air inlet and aluminum fins of outdoor unit. It may cause injury and/or damage the heat transfer surface.
- This appliance is NOT intended for use by young children or impaired persons without proper supervision.
- Young children should be supervised to ensure that they DO NOT play with or near the air flow of this appliance.
- Do not pull at the conduit or hang anything on it. Otherwise it will cause fire or electric shock.
- Do not touch the heat exchanger fins. Improper handling may result in injury.
- Do not turn off the power immediately after stopping operation. Always wait at least five minutes before turning off the power. Otherwise, water leakage and trouble may occur.

- To avoid personal injury or equipment damage be sure to stop the operation, turn the breaker off or pull out the supply cord before cleaning or servicing the unit. NOTE: More than one disconnect may be required to shut off all power. 
- Do not connect the air conditioner to a power supply different from the one specified. It may cause improper operation or fire.
- Depending on the environment, state and local electrical codes, a ground fault circuit interrupter may be required. Improper grounding or lack of a ground fault circuit interrupter may result in electrical shock, injuries, or death.
- Arrange the drain hose to ensure smooth drainage. Improper drainage may cause water damage to the building, or it's furnishing.
- Depending on the usage environment, water may leak from the air conditioner. If this happens, contact your Daikin Dealer.
- Safely dispose of the packing materials. Packing materials, such as nails and other metal or wooden parts, may cause stabs or other injuries. Tear apart and throw away plastic packaging bags so that children will not play with them. If children play with a plastic bag which was not torn apart, they face the risk of suffocation.
- The remote controller should be installed in such away that children cannot play with it.
- Do not place objects in direct proximity of the outdoor unit and do not let leaves and other debris accumulate around the unit. Leaves are a hotbed for small animals which can enter the unit. Once in the unit, such animals can cause malfunctions, smoke or fire when making contact with electrical parts.

- Do not operate the air conditioner with wet hands. 

- Do not wash the indoor unit with excessive water, only use a slightly wet cloth. 
- Do not place things such as vessels containing water or anything else on top of the unit. Water may penetrate into the unit and degrade electrical insulations, resulting in an electric shock.

Installation site.

- To install the air conditioner in the following types of environments, consult your authorized dealer.
 - Places with an oily ambient or where steam or soot occurs.
 - Salty environment such as coastal areas.
 - Places where sulfide gas occurs such as hot springs.
 - Places where snow may block the outdoor unit.

The drain from the outdoor unit must be discharged to a place of good drainage.

Consider nuisance to your neighbors from noises.

- For installation, choose a place as described below.
 - A place solid enough to bear the weight of the unit which does not amplify the operation noise or vibration.
 - A place from where the air discharged from the outdoor unit or the operation noise will not annoy your neighbors.

Electrical work.

- For power supply, be sure to use a separate power circuit dedicated to the air conditioner. Follow all local and state electrical codes.

System relocation.

- Relocating the air conditioner requires specialized knowledge and skills. Please consult your authorized dealer if relocation is necessary for moving or remodeling.

13.2 The Single Split Duct-Free System FTXS09/12DVJU

Names of parts

■ Indoor Unit

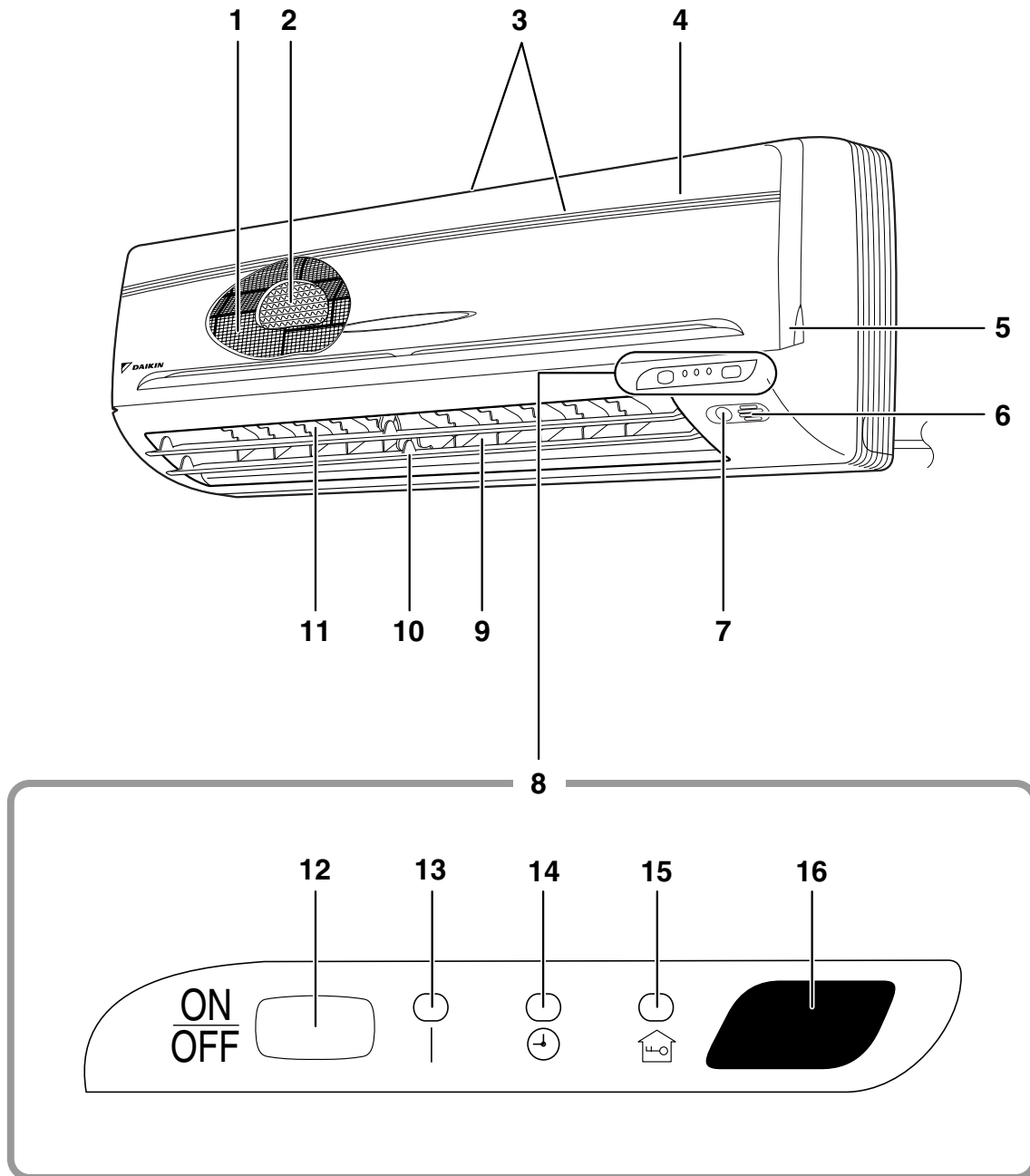

■ Outdoor Unit

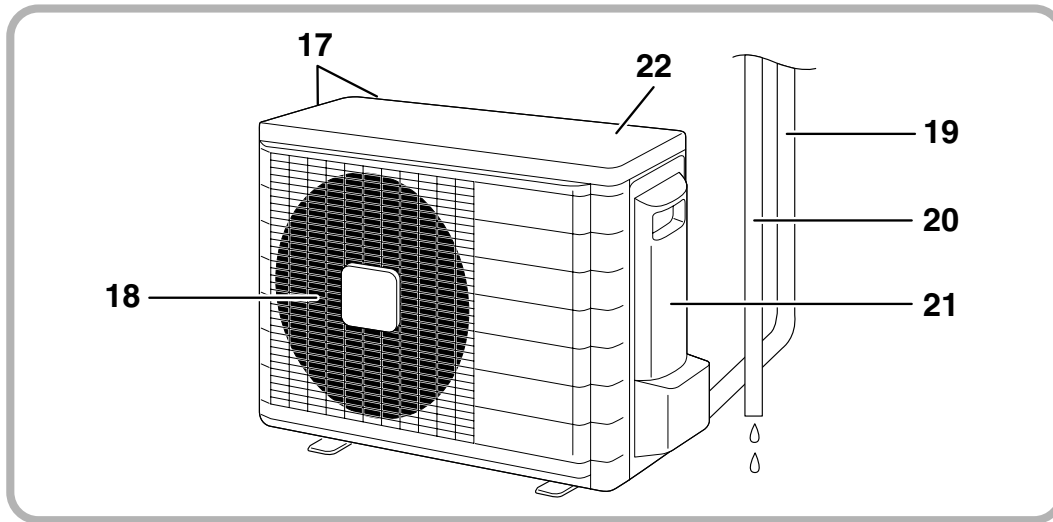

■ Indoor Unit

1. Air filter

2. Air-purifying filter with photocatalytic deodorizing function:

- These filters are attached to the inside of the air filters.

3. Air inlet

4. Front panel

5. Panel tab

6. Room temperature sensor:

- It senses the air temperature around the unit.

7. INTELLIGENT EYE sensor:

- It detects the movements of people and automatically switches between normal operation and energy saving operation. (page 18.)

8. Display

9. Air outlet

10. Flaps (horizontal blades): (page 12.)

11. Louvers (vertical blades):

- The louvers are inside of the air outlet. (page 13.)

12. Indoor Unit ON/OFF switch: (page 10.)

- Push this switch once to start operation. Push once again to stop it.
- The operation mode refers to the following table.

Mode	Temperature setting	Airflow rate
AUTO	77°F	AUTO

- This switch is useful when the remote controller is missing.

13. Operation lamp (green)

14. TIMER lamp (yellow): (page 20.)

15. HOME LEAVE lamp (red): (page 16.)

16. Signal receiver:

- It receives signals from the remote controller.
- When the unit receives a signal, you will hear a short beep.
 - Operation startbeep-beep
 - Settings changedbeep
 - Operation stopbeeeeeep

■ Outdoor Unit

17. Air inlet: (Back and side)

18. Air outlet

19. Refrigerant piping and inter-unit cable

20. Drain hose

21. Earth grounding terminal:

- It is inside of this cover.

22. Outside air temperature sensor:

- It senses the ambient temperature around the unit.

Appearance of the outdoor unit may differ from some models.

■ Remote Controller

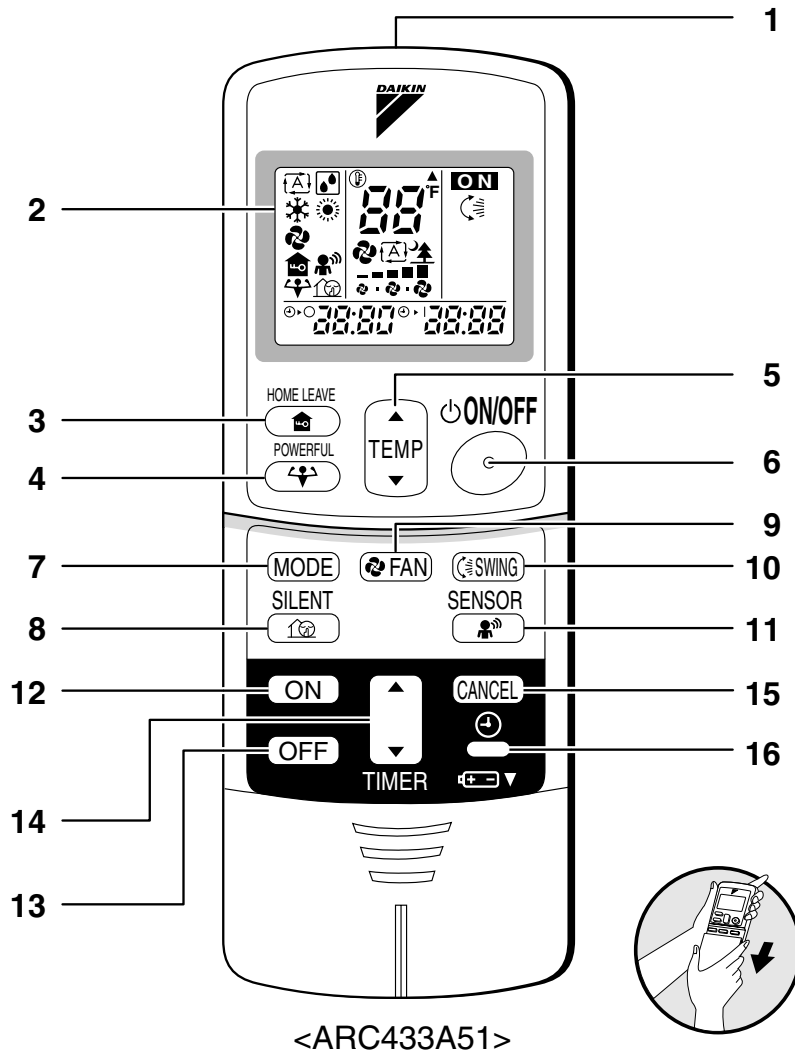

<ARC433A51>

1. Signal transmitter:

- It sends signals to the indoor unit.

2. Display:

- It displays the current settings.
(In this illustration, each section is shown with all its displays ON for the purpose of explanation.)

3. HOME LEAVE button:

HOME LEAVE operation (page 16.)

4. POWERFUL button: (Maximum operation)

POWERFUL operation (page 14.)

5. TEMPERATURE adjustment buttons:

- It changes the temperature setting.

6. ON/OFF button:

- Press this button once to start operation.
Press once again to stop it.

7. MODE selector button:

- It selects the operation mode.
(AUTO/DRY/COOL/HEAT/FAN) (page 10.)

8. SILENT button: OUTDOOR UNIT SILENT operation (page 15.)

9. FAN setting button:

- It selects the airflow rate setting.

10. SWING button: (page 12.)

11. SENSOR button: INTELLIGENT EYE operation (page 18.)

12. ON TIMER button: (page 21.)

13. OFF TIMER button: (page 20.)

14. TIMER Setting button:

- It changes the time setting.

15. TIMER CANCEL button:

- It cancels the timer setting.

16. CLOCK button: (page 9.)

Preparation Before Operation

■ To set the batteries

1. Slide the front cover to take it off.
2. Set two dry batteries (AAA).
3. Set the front cover as before.

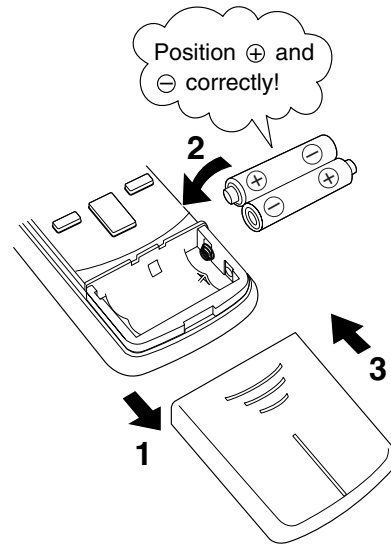

ATTENTION

■ About batteries

- When replacing the batteries, use batteries of the same type, and replace the two old batteries together.
- When the system is not used for a long time, take the batteries out. In case the remote controller is not used for a long time remove all batteries in order to prevent liquid leak of the battery.
- We recommend replacing once a year, although if the remote controller display begins to fade or if reception deteriorates, please replace with new alkali batteries. Using manganese batteries reduces the lifespan.
- The attached batteries are provided for the initial use of the system. The usable period of the batteries may be short depending on the manufactured date of the air conditioner.
- Pressing two or more buttons simultaneously may cause the strange display of the remote controller. The remote controller is not malfunction. In this case take the batteries out and reset them.

■ Replacing the Batteries

- When replacing the battery, remove the old battery, wait one minute, and then insert the new battery.

Preparation Before Operation

■ To operate the remote controller

- To use the remote controller, aim the transmitter at the indoor unit.
If there is anything to block signals between the unit and the remote controller, such as a curtain, the unit will not operate.
- Do not drop the remote controller. Do not get it wet.
- The maximum distance for communication is about 23 Ft..

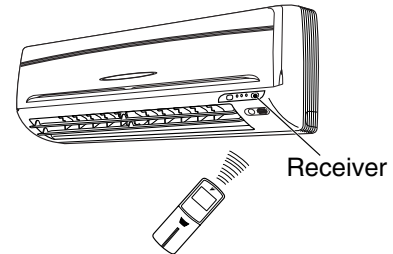

■ To fix the remote controller holder on the wall

1. Choose a place from where the signals reach the unit.
2. Fix the holder to a wall, a pillar, etc. with the screws supplied with the holder.
3. Place the remote controller in the remote controller holder.

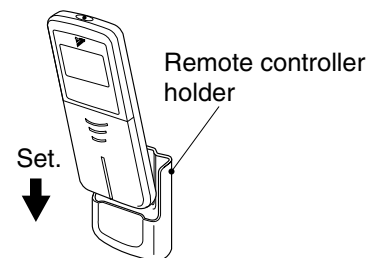

- To remove, pull it upwards.

ATTENTION

■ About remote controller

- Do not put the remote controller in the following places.
 - In direct sunlight.
 - In vicinity of a heater.
- Dust on the signal transmitter or receiver will reduce the sensitivity. Wipe off dust with soft cloth.
- Signal communication may be disabled if an electronic-starter-type fluorescent lamp (such as inverter-type lamps) is in the room. Consult your authorized dealer if that is the case.
- If the remote controller signals happen to operate another appliance, move that appliance to somewhere else, or consult your authorized dealer.

■ To set the clock

1. Press “CLOCK button”.

0:00 is displayed.

⌚ blinks.

2. Press “TIMER setting button” to set the clock to the present time.

Holding down “▲” or “▼” button rapidly increases or decreases the time display.

3. Press “CLOCK button”.

⌚ blinks.

■ Turn the breaker ON

- Turning ON the breaker opens the flap, then closes it again. (This is a normal procedure.)

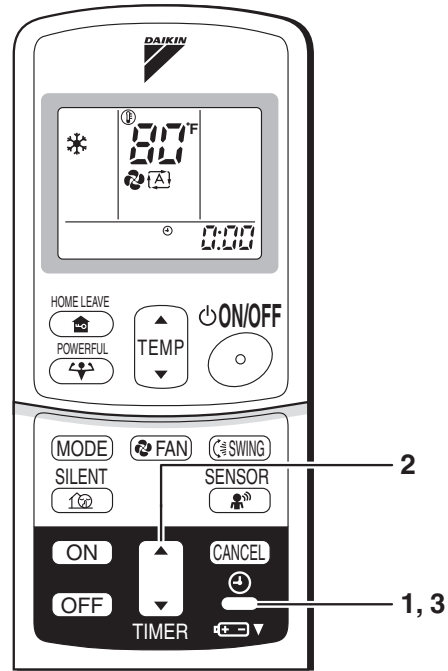

NOTE

■ Tips for saving energy

- Be careful not to cool (heat) the room too much. Keeping the temperature setting at a moderate level helps save energy.
- Cover windows with a blind or a curtain. Blocking sunlight and air from outdoors increases the cooling (heating) effect.
- Clogged air filters cause inefficient operation and waste energy. Clean them once every two weeks.

Recommended temperature setting

For cooling: 78°F – 82°F
For heating: 68°F – 75°F

■ Please note

- When the main power switch is turned on, some watts of electricity are being used even when the system is not operating.
- If you are not going to use the air conditioner for a long period, for example in spring or autumn, turn the breaker OFF to save energy.
- Use the air conditioner in the following conditions.

Mode	Operating conditions	If operation is continued out of this range
COOL	Outdoor temperature: 14 to 115 °F Indoor temperature: 64 to 90 °F Indoor humidity: 80% max.	<ul style="list-style-type: none"> • A safety device may work to stop the operation under 0 °F and over 115 °F outdoor temperature. • See Note 2 for 0 °F to 14 °F operation. • Condensation may occur on the indoor unit and drip.
HEAT	Outdoor temperature: 5 to 64 °F Indoor temperature: 50 to 86 °F	<ul style="list-style-type: none"> • A safety device may work to stop the operation under 0 °F or over 64 °F outdoor temperature. See the Note 3 for 0 °F to 5 °F.
DRY	Outdoor temperature: 14 to 115 °F Indoor temperature: 64 to 90 °F Indoor humidity: 80% max.	<ul style="list-style-type: none"> • A safety device may work to stop the operation. • Condensation may occur on the indoor unit and drip.

- Operation outside this humidity or temperature range may cause a safety device to disable the system.

<Note 1> A Breaker must be turned on for 24 hours before the operation start if the ambient is below 14 °F, otherwise the unit will not start operation smoothly.

<Note 2> 1. Use low outdoor ambient cooling operation for equipment cooling applications only. This operation is not intended for human comfort cooling.

2. Intermittent noises may be produced by the indoor unit due to the outdoor fan rotation speed change.

3. Do not place humidifiers or other items which might raise the humidity in rooms at 0 to 14 °F outdoor temperature. A humidifier may cause condensation to drip from the indoor unit outlet vent.

4. Set the indoor unit at the highest air flow rate.

<Note 3> When the outdoor temperature is 0 to 5 degrees F, the system may not have sufficient cooling capacity.

AUTO · DRY · COOL · HEAT · FAN Operation

The air conditioner operates with the operation mode of your choice.
 From the next time on, the air conditioner will operate with the same operation mode.

■ To start operation

1. Press “MODE selector button” and select a operation mode.

- Each pressing of the button advances the mode setting in sequence.

- ☐A: AUTO
- ☐D: DRY
- ☐C: COOL
- ☐H: HEAT
- ☐F: FAN



2. Press “ON/OFF button” .

- The OPERATION lamp lights up.



■ To stop operation

3. Press “ON/OFF button” again.

- Then OPERATION lamp goes off.

■ To change the temperature setting



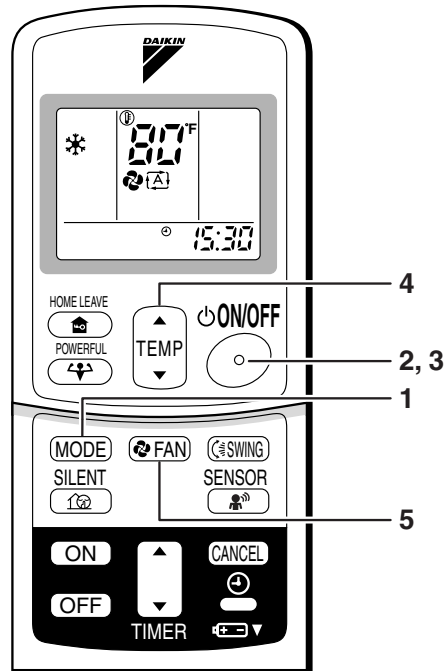

4. Press “TEMPERATURE adjustment button”.

DRY or FAN mode	AUTO or COOL or HEAT mode
The temperature setting is not variable.	Press “▲” to raise the temperature and press “▼” to lower the temperature.
	Set to the temperature you like. 



■ To change the airflow rate setting

5. Press “FAN setting button”.

DRY mode	AUTO or COOL or HEAT or FAN mode
The airflow rate setting is not variable.	Five levels of airflow rate setting from “  ” to “  ” plus “  ” “  ” are available. 

- Indoor unit quiet operation

When the airflow is set to “”, the noise from the indoor unit will become quieter.
Use this when making the indoor unit quieter.

The unit might lose capacity when the airflow rate is set to a low level.

NOTE

■ Note on HEAT operation

- Since this air conditioner heats the room by taking heat from outdoor air to indoors, the heating capacity becomes smaller in lower outdoor temperatures. If the heating effect is insufficient, it is recommended to use another heating appliance in combination with the air conditioner.
- The heat pump system heats the room by circulating hot air around all parts of the room. After the start of heating operation, it takes some time before the room gets warmer.
- In heating operation, frost may occur on the outdoor unit and lower the heating capacity. In that case, the system switches into defrosting operation to take away the frost.
- During defrosting operation, hot air does not flow out of indoor unit.

■ Note on COOL operation

- This air conditioner cools the room by blowing the hot air in the room outside, so if the outside temperature is high, performance drops.

■ Note on DRY operation

- The computer chip works to rid the room of humidity while maintaining the temperature as much as possible. It automatically controls temperature and fan strength, so manual adjustment of these functions is unavailable.

■ Note on AUTO operation

- In AUTO operation, the system selects an appropriate operation mode (COOL or HEAT) based on the room temperature at the start of the operation.
- The system automatically reselects setting at a regular interval to bring the room temperature to user-setting level.
- If you do not like AUTO operation, you can manually select the operation mode and setting you like.

■ Note on airflow rate setting

- At smaller airflow rates, the cooling (heating) effect is also less.

Adjusting the Airflow Direction

You can adjust the airflow direction to increase your comfort.

■ To adjust the horizontal blades (flaps)

1. Press “SWING button”.

 The display will light up and the flaps will begin to swing.

2. When the flaps have reached the desired position, press “SWING button” once more.

The display will go blank.

The flaps will stop moving.

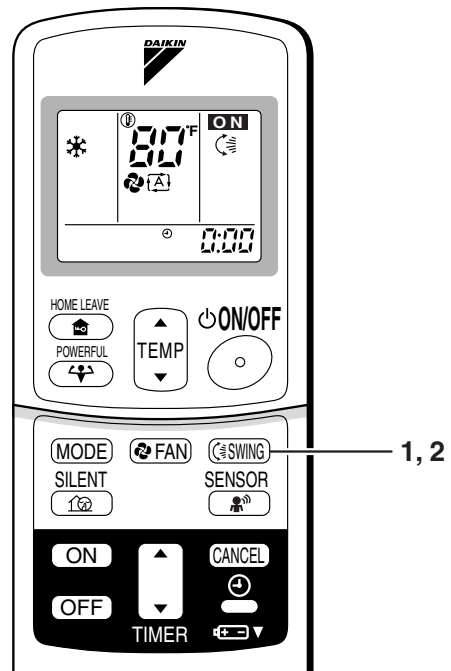

■ To adjust the vertical blades (louvers)

Hold the knob and move the louvers.

(You will find a knob on the left-side and the right-side blades.)

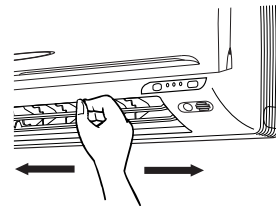

Notes on flaps and louvers angles

- When “**SWING button**” is selected, the flaps swinging range depends on the operation mode. (See the figure.)

■ ATTENTION

- Always use a remote controller to adjust the flaps angle. If you attempt to move it forcibly with hand when it is swinging, the mechanism may be broken.
- Be careful when adjusting the louvers. Inside the air outlet, a fan is rotating at a high speed and may cause bodily injury if fan comes in contact with fingers.

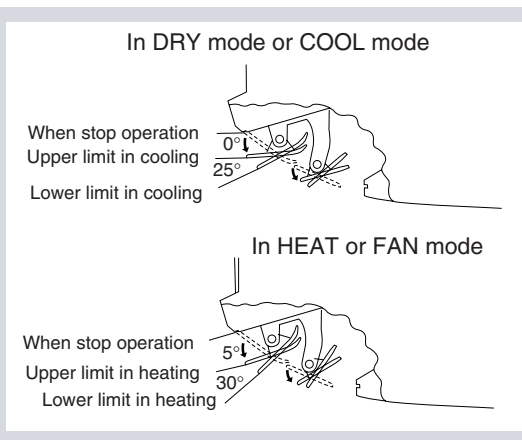

POWERFUL Operation

POWERFUL operation quickly maximizes the cooling (heating) effect in any operation mode. You can get the maximum capacity.

■ To start POWERFUL operation

1. Press “POWERFUL button”.

- POWERFUL operation ends in 20 minutes. Then the system automatically operates again with the settings which were used before POWERFUL operation.
- When using POWERFUL operation, there are some functions which are not available.
- “” is displayed on the LCD.

■ To cancel POWERFUL operation

2. Press “POWERFUL button” again.

- “” disappears from the LCD.

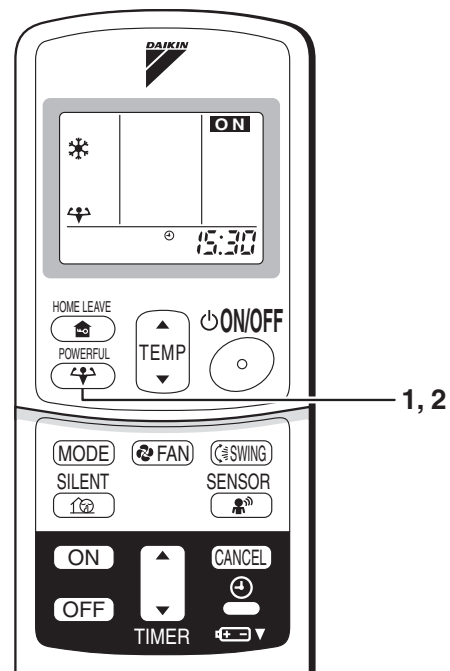

NOTE

■ Notes on POWERFUL operation

- POWERFUL Operation cannot be used together with SILENT Operation. Priority is given to the function of whichever button is pressed last.
- POWERFUL Operation can only be set when the unit is running. Pressing the operation stop button causes the settings to be canceled, and the “” disappears from the LCD.
- **In COOL and HEAT mode**
To maximize the cooling (heating) effect, the capacity of outdoor unit must be increased and the airflow rate be fixed to the maximum setting.
The temperature and airflow settings are not variable.
- **In DRY mode**
The temperature setting is lowered by 4.5° F and the airflow rate is slightly increased.
- **In FAN mode**
The airflow rate is fixed to the maximum setting.

OUTDOOR UNIT SILENT Operation

OUTDOOR UNIT SILENT operation lowers the noise level of the outdoor unit by changing the fan speed on the outdoor unit. This function is convenient during night.

■ To start OUTDOOR UNIT SILENT operation

1. Press “SILENT button”.

- “” is displayed on the LCD.

■ To cancel OUTDOOR UNIT SILENT operation

2. Press “SILENT button” again.

- “” disappears from the LCD.

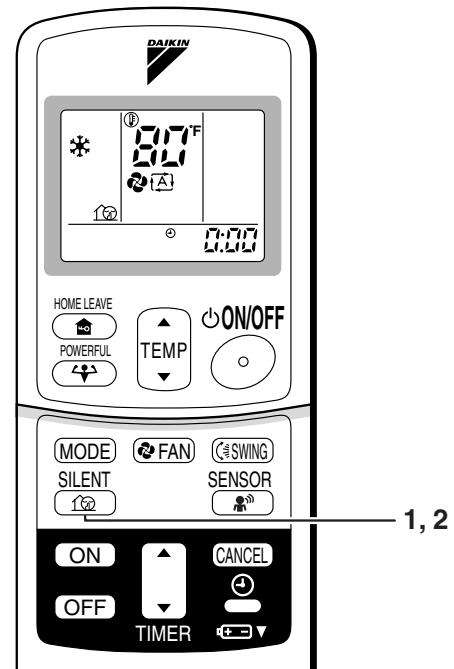

NOTE

■ Note on OUTDOOR UNIT SILENT operation

- This function is available in COOL, HEAT, and AUTO modes. (This is not available in FAN and DRY modes.)
- POWERFUL operation and OUTDOOR UNIT SILENT operation cannot be used at the same time. Priority is given to the function of whichever button is pressed last.
- If operation is stopped using the remote controller or the main unit ON/OFF switch when using OUTDOOR UNIT SILENT operation, “” will remain on the remote controller display.

HOME LEAVE Operation

HOME LEAVE operation is a function which allows you to record your preferred temperature and airflow rate settings.

■ To start HOME LEAVE operation

1. Press “HOME LEAVE button” .
 - “” is displayed on the LCD.
 - The HOME LEAVE lamp lights up.



■ To cancel HOME LEAVE operation

2. Press “HOME LEAVE button” again.
 - “” disappears from the LCD.
 - The HOME LEAVE lamp goes off.

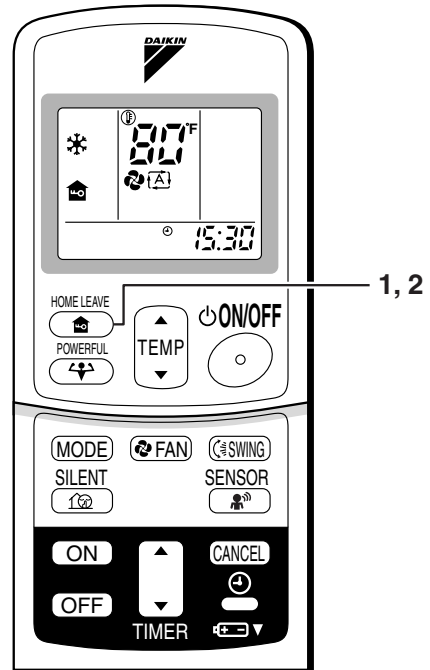

Before using HOME LEAVE operation.

■ To set the temperature and airflow rate for HOME LEAVE operation

When using HOME LEAVE operation for the first time, please set the temperature and airflow rate for HOME LEAVE operation. Record your preferred temperature and airflow rate.

	Initial setting		Selectable range	
	Temperature	Airflow rate	Temperature	Airflow rate
Cooling	77°F	AUTO	64-90°F	5 step, AUTO and SILENT
Heating	77°F	AUTO	50-86°F	5 step, AUTO and SILENT

1. Press “HOME LEAVE button”. Make sure “” is displayed in the remote controller display.
2. Adjust the set temperature with “▲” or “▼” as you like.
3. Adjust the airflow rate with “FAN” setting button as you like.

Home leave operation will run with these settings the next time you use the unit. To change the recorded information, repeat steps 1 – 3.

■ What's the HOME LEAVE operation?

Is there a set temperature and airflow rate which is most comfortable, a set temperature and airflow rate which you use the most? HOME LEAVE operation is a function that allows you to record your favorite set temperature and airflow rate. You can start your favorite operation mode simply by pressing the HOME LEAVE button on the remote controller. This function is convenient in the following situations.

■ Useful in these cases

1. Use as an energy-saving mode.

Set the temperature 3-5°F higher (cooling) or lower (heating) than normal. Setting the fan speed to the lowest setting allows the unit to be used in energy-saving mode. Also convenient for use while you are out or sleeping.

• Every day before you leave the house...

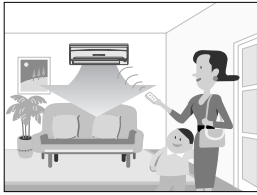

When you go out, push the "HOME LEAVE Operation" button, and the air conditioner will adjust capacity to reach the preset temperature for HOME LEAVE Operation.

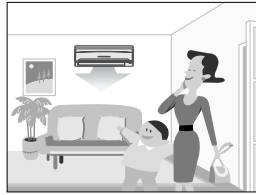

When you return, you will be welcomed by a comfortably air conditioned room.

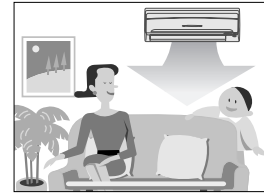

Push the "HOME LEAVE Operation" button again, and the air conditioner will adjust capacity to the set temperature for normal operation.

• Before bed...

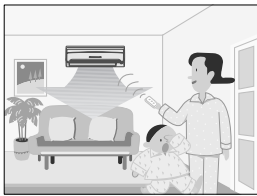

Set the unit to HOME LEAVE Operation before leaving the living room when going to bed.



The unit will maintain the temperature in the room at a comfortable level while you sleep.

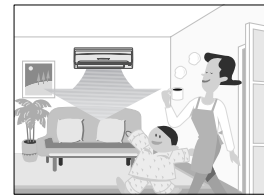

When you enter the living room in the morning, the temperature will be just right. Disengaging HOME LEAVE Operation will return the temperature to that set for normal operation. Even the coldest winters will pose no problem!

2. Use as a favorite mode

Once you record the temperature and airflow rate settings you most often use, you can retrieve them by pressing HOME LEAVE button. You do not have to go through troublesome remote controller operations.

NOTE

- Once the temperature and airflow rate for HOME LEAVE operation are set, those settings will be used whenever HOME LEAVE operation is used in the future. To change these settings, please refer to the "Before using HOME LEAVE operation" section above.
- HOME LEAVE operation is only available in COOL and HEAT mode. It cannot be used in AUTO, DRY, and FAN mode.
- HOME LEAVE operation runs in accordance with the previous operation mode (COOL or HEAT) before using HOME LEAVE operation.
- HOME LEAVE operation and POWERFUL operation cannot be used at the same time. Last button that was pressed has priority.
- The operation mode cannot be changed while HOME LEAVE operation is being used.
- When operation is shut off during HOME LEAVE operation, using the remote controller or the indoor unit ON/OFF switch, "🏠" will remain on the remote controller display.

INTELLIGENT EYE Operation

“INTELLIGENT EYE” is the infrared sensor which detects the human movement.

■ To start INTELLIGENT EYE operation

1. Press “SENSOR button”.
 - “” is displayed on the LCD.

■ To cancel the INTELLIGENT EYE operation

2. Press “SENSOR button” again.
 - “” disappears from the LCD.

[EX.]

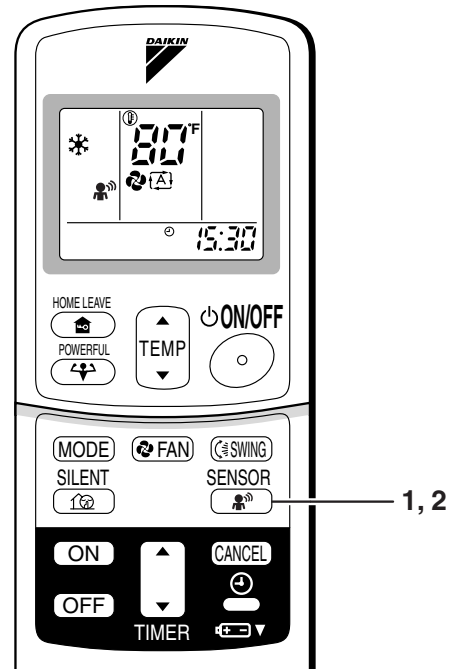
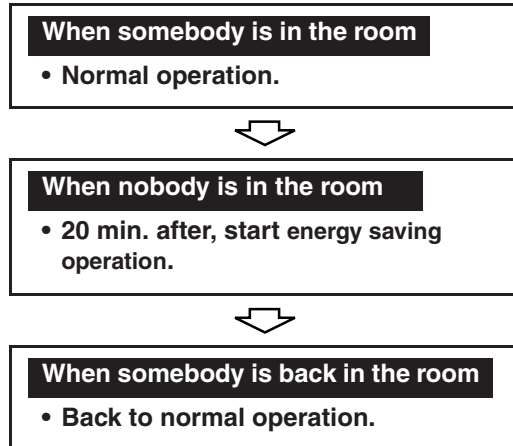

■ To adjust the angle of the INTELLIGENT EYE sensor

- You can adjust the angle of the INTELLIGENT EYE sensor to increase the detection area.
(Adjustable angle: 15° to right and left of centre)

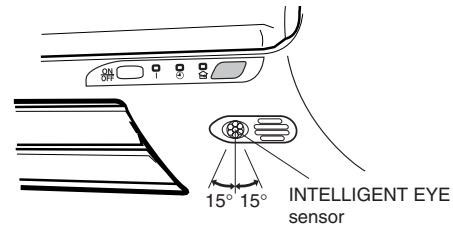

- Gently push and slide the sensor to adjust the angle.
- After adjusting the angle, wipe the sensor gently with a clean cloth, being careful not to scratch the sensor.

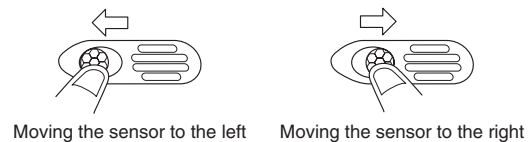

“INTELLIGENT EYE” is useful for Energy Saving.

■ Energy saving operation

- Change the temperature -3.6°F in heating / $+3.6^{\circ}\text{F}$ in cooling / $+1.8^{\circ}\text{F}$ in dry mode from set temperature.
- Decrease the airflow rate slightly in fan operation. (In FAN mode only)

Notes on “INTELLIGENT EYE”

- Application range is as follows.

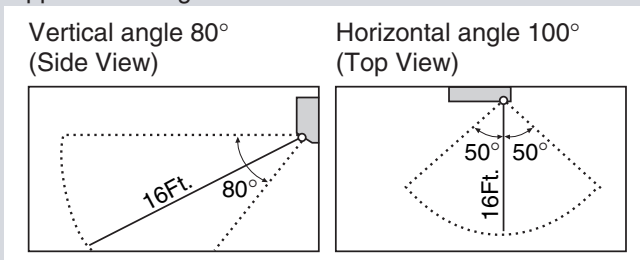

- Sensor may not detect moving objects further than 16Ft. away. (Check the application range)
- Sensor detection sensitivity changes according to indoor unit location, the speed of passersby, temperature range, etc.
- The sensor also mistakenly detects pets, sunlight, fluttering curtains and light reflected off of mirrors as passersby.
- INTELLIGENT EYE operation will not go on during powerful operation.
- Night set mode (page 20.) will not go on during your use of INTELLIGENT EYE operation.

⚠ CAUTION

- Do not place large objects near the sensor.
Also keep heating units or humidifiers outside the sensor's detection area. This sensor can detect objects it shouldn't as well as not detect objects it should.
- Do not hit or violently push the INTELLIGENT EYE sensor. This can lead to damage and malfunction.

TIMER Operation

Timer functions are useful for automatically switching the air conditioner on or off at night or in the morning. You can also use OFF TIMER and ON TIMER in combination.

■ To use OFF TIMER operation

- Check that the clock is correct. If not, set the clock to the present time. (page 9.)

1. Press “OFF TIMER button”.

0:00 is displayed.

⊙-○ blinks.

2. Press “TIMER Setting button” until the time setting reaches the point you like.

- Every pressing of either button increases or decreases the time setting by 10 minutes. Holding down either button changes the setting rapidly.

3. Press “OFF TIMER button” again.

- The TIMER lamp lights up.

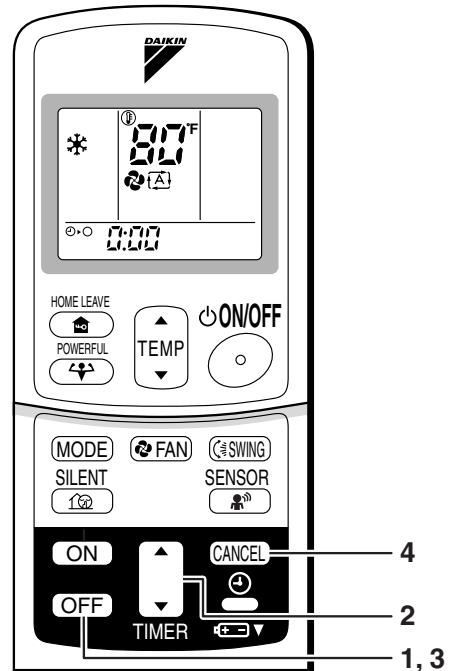

■ To cancel the OFF TIMER operation

4. Press “CANCEL button”.

- The TIMER lamp goes off.

NOTE

- When TIMER is set, the present time is not displayed.
- Once you set ON, OFF TIMER, the time setting is kept in the memory. (The memory is lost when remote controller batteries are replaced.)
- When operating the unit via the ON/OFF Timer, the actual length of operation may vary from the time entered by the user.

■ NIGHT SET MODE

When the OFF TIMER is set, the air conditioner automatically adjusts the temperature setting (1°F up in COOL, 3.6°F down in HEAT) to prevent excessive cooling (heating) for your pleasant sleep.

■ To use ON TIMER operation

- Check that the clock is correct. If not, set the clock to the present time. (page 9.)

1. Press “ON TIMER button”.

5:00 is displayed.

⊕▷| blinks.

2. Press “TIMER Setting button” until the time setting reaches the point you like.

- Every pressing of either button increases or decreases the time setting by 10 minutes. Holding down either button changes the setting rapidly.

3. Press “ON TIMER button” again.

- The TIMER lamp lights up.



■ To cancel ON TIMER operation

4. Press “CANCEL button”.

- The TIMER lamp goes off.

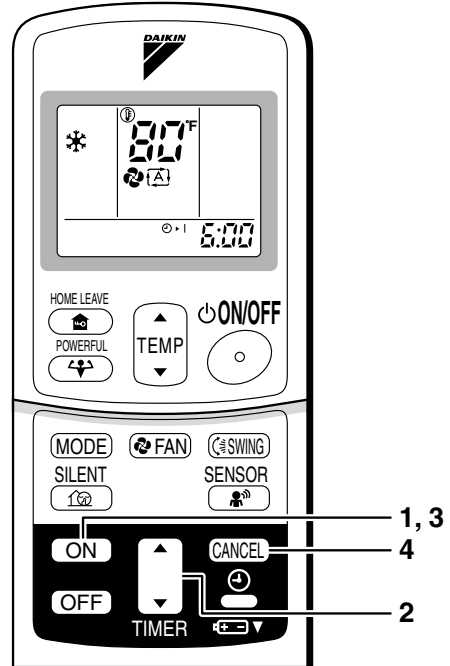

■ To combine ON TIMER and OFF TIMER

- A sample setting for combining the two timers is shown below.

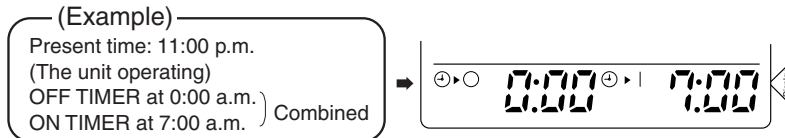

ATTENTION

■ In the following cases, set the timer again.

- After a breaker has turned OFF.
- After a power failure.
- After replacing batteries in the remote controller.

Care and Cleaning

⚠ CAUTION Before cleaning, be sure to stop the operation and turn the breaker OFF.

Units

To avoid possible bodily injury, units should be shutoff or disconnected before any cleaning or servicing is attempted.

■ Indoor unit, Outdoor unit and Remote controller

1. Wipe them with dry soft cloth.

■ Front panel

1. Open the front panel.

- Hold the panel by the tabs on the two sides and lift it until it stops with a click.

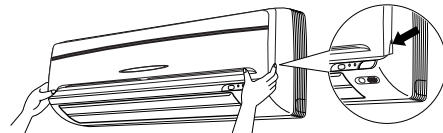

2. Remove the front panel.

- Supporting the front panel with one hand, release the lock by sliding down the knob with the other hand.
- To remove the front panel, pull it toward yourself with both hands.

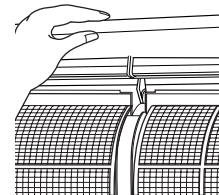

3. Clean the front panel.

- Wipe it with a soft cloth soaked in water.
- Only neutral detergent may be used.
- In case of washing the panel with water, dry it with cloth, dry it up in the shade after washing.

4. Attach the front panel.

- Set the 3 keys of the front panel into the slots and push them in all the way.
- Close the front panel slowly and push the panel at the 3 points. (1 on each side and 1 in the middle.)
- Check to see if the rotating axis in the upper center section is moving.

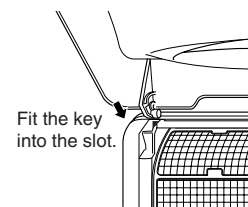

⚠ CAUTION

- Don't touch the metal parts of the indoor unit. If you touch those parts, this may cause an injury.
- When removing or attaching the front panel, use a robust and stable stool and watch your steps carefully.
- When removing or attaching the front panel, support the panel securely with hand to prevent it from falling.
- For cleaning, do not use hot water above 104°F, benzene, gasoline, thinner, nor other volatile oils, polishing compound, scrubbing brushes, nor other hand stuff.
- After cleaning, make sure that the front panel is securely fixed.

Filters

1. **Open the front panel.** (page 22.)
2. **Pull out the air filters.**
 - Push a little upwards the tab at the center of each air filter, then pull it down.
3. **Take off the air-purifying filter with photocatalytic deodorizing function.**
 - Hold the recessed parts of the frame and unhook the four claws.
4. **Clean or replace each filter.**
See figure.

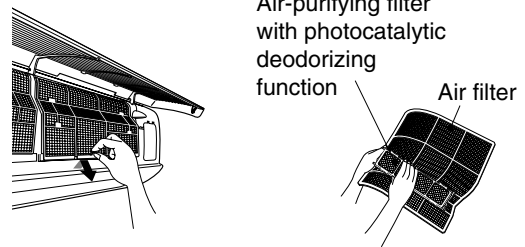
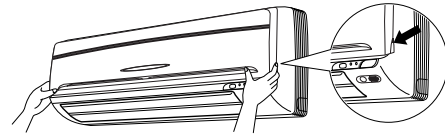

5. **Set the air filter and the air-purifying filter with photocatalytic deodorizing function as they were and close the front panel.**
 - Insert claws of the filters into slots of the front panel. Close the front panel slowly and push the panel at the 3 points. (1 on each side and 1 in the middle.)

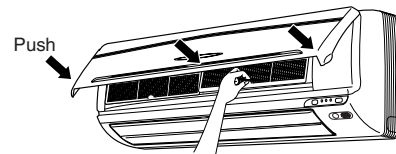

■ Air Filter

1. **Wash the air filters with water or clean them with vacuum cleaner.**
 - If the dust does not come off easily, wash them with neutral detergent thinned with lukewarm water, then dry them up in the shade.
 - It is recommended to clean the air filters every two weeks.

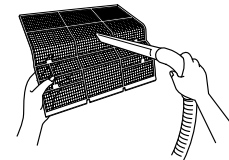

■ Air-purifying filter with photocatalytic deodorizing function (gray)

The Air-purifying filter with photocatalytic deodorizing function can be renewed by washing it with water once every 6 months. We recommend replacing it once every 3 years.

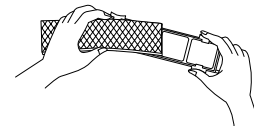

[Maintenance]

1. **Remove dust with a vacuum cleaner and wash lightly with water.**
2. **If it is very dirty, soak it for 10 to 15 minutes in water mixed with a neutral cleaning agent.**
3. **Do not remove filter from frame when washing with water.**
4. **After washing, shake off remaining water and dry in the shade.**
5. **Since the material is made out of paper, do not wring out the filter when removing water from it.**

[Replacement]

1. **Remove the tabs on the filter frame and replace with a new filter.**
 - Dispose of the old filter as flammable waste.

Check

Check that the base, stand and other fittings of the outdoor unit are not decayed or corroded. Check the units to ensure they are level and secure.
Check that nothing blocks the air inlets and the outlets of the indoor unit and the outdoor unit.
Check that the water drains smoothly out of the drain hose during COOL or DRY operation. <ul style="list-style-type: none"> • If no drain water is seen, water may be leaking from the indoor unit. Stop operation and consult your authorized dealer.

■ Before a long idle period

- 1. Operate the “FAN only” for several hours on a warm day to dry out the inside.**
 - Press “MODE selector button” and select “FAN” operation.
 - Press “ON/OFF button” and start operation.
- 2. After operation stops, turn off the electrical circuit breaker for the room air conditioner.**
- 3. Remove and clean the air filters. Reinstall filters after cleaning.**
- 4. Take out batteries from the remote controller.**

NOTE

- Operation with dirty filters:
 - (1) cannot deodorize the air. (2) cannot clean the air.
 - (3) results in poor heating or cooling. (4) may cause odor.
- To order air-purifying filter with photocatalytic deodorizing function, contact your authorized dealer where you bought the air conditioner.
- Dispose of old filters as required by local codes.

Item	Part No.
Air-purifying filter with photocatalytic deodorizing function. (with frame) 1 set	KAF918A43
Air-purifying filter with photocatalytic deodorizing function. (without frame) 1 set	KAF918A44

Trouble Shooting

Conditions that appear to be abnormal but are not operational problems.

The following cases are not abnormal problems and you may just continue using it.

Case	Explanation
Operation does not start quickly. <ul style="list-style-type: none"> • When ON/OFF button was pressed soon after operation was stopped. • When the mode was reselected. 	<ul style="list-style-type: none"> • This is to protect the air conditioner. You should wait for about 3 minutes.
Hot air does not flow out soon after the start of heating operation.	<ul style="list-style-type: none"> • The air conditioner is warming up. You should wait for 1 to 4 minutes. (The system is designed to start discharging air only after it has reached a certain temperature.)
The heating operation stops suddenly and a flowing sound is heard.	<ul style="list-style-type: none"> • The system is taking away the frost on the outdoor unit. You should wait for about 3 to 8 minutes.
The outdoor unit emits water or steam.	<ul style="list-style-type: none"> ■ In HEAT mode <ul style="list-style-type: none"> • The frost on the outdoor unit melts into water or steam when the air conditioner is in defrost operation. ■ In COOL or DRY mode <ul style="list-style-type: none"> • Moisture in the air condenses into water on the cool surface of outdoor unit piping and drips.
Mists come out of the indoor unit.	<ul style="list-style-type: none"> ■ This happens when the air in the room is cooled into mist by the cold airflow during cooling operation.
The indoor unit gives out odor.	<ul style="list-style-type: none"> ■ This happens when smells of the room, furniture, or cigarettes are absorbed into the unit and discharged with the airflow. (If this happens, we recommend you to have the indoor unit washed by a technician. Consult your authorized dealer where you bought the air conditioner.)
The outdoor fan rotates while the air conditioner is not in operation.	<ul style="list-style-type: none"> ■ After operation is stopped: <ul style="list-style-type: none"> • The outdoor fan continues rotating for another 60 seconds for system protection. ■ While the air conditioner is not in operation: <ul style="list-style-type: none"> • When the outdoor temperature is very high, the outdoor fan starts rotating for system protection.
The operation stopped suddenly. (OPERATION lamp is on.)	<ul style="list-style-type: none"> ■ For system protection, the air conditioner may stop operating on a sudden large voltage fluctuation. It automatically resumes operation in about 3 minutes.

Check again.

Please check again before calling a repair person.

Case	Check
The air conditioner does not operate. (OPERATION lamp is off.)	<ul style="list-style-type: none"> • Has a breaker been turned OFF or a fuse blown? • Is there a power failure? • Are fresh batteries installed in the remote controller? • Is the timer setting correct?
Cooling (Heating) effect is poor.	<ul style="list-style-type: none"> • Are the air filters clean? • Is anything blocking the air inlet or the outlet of the indoor and the outdoor units? • Is the temperature setting appropriate? • Are the windows and doors closed? • Are the airflow rate and the air direction set appropriately? • Is the unit set to the INTELLIGENT EYE mode? (page 18.)
Operation stops suddenly. (OPERATION lamp flashes.)	<ul style="list-style-type: none"> • Are the air filters clean? • Is there anything blocking the air inlet or the outlet of the indoor and the outdoor units? <p>Turn the electrical breaker off, clean the air filters or take all obstacles away from inlet and outlet. Then turn the breaker ON again and try operating the air conditioner with the remote controller. If the lamp still flashes, call your authorized dealer where you bought the air conditioner.</p>
An abnormal functioning happens during operation.	<ul style="list-style-type: none"> • The air conditioner may malfunction with lightning or radio waves. Turn the circuit breaker OFF, to reset. Then turn it ON again and try operating the air conditioner with the remote controller.

Call your authorized dealer immediately.

WARNING

- When an abnormality (such as a burning smell) occurs, stop operation and turn the circuit breaker OFF. Continued operation in an abnormal condition may result in troubles, electric shocks or fire. Consult your authorized dealer where you bought the air conditioner.
- Do not attempt to repair or modify the air conditioner by yourself. Work performed by untrained persons could result in electric shocks, personal injury, fire, or additional damage to equipment. Consult the service shop where you bought the air conditioner.

If one of the following symptoms takes place, call your authorized dealer immediately.

- **The power cord is abnormally hot or damaged.**
- **An abnormal sound is heard during operation.**
- **The safety breaker, a fuse, or the ground leakage breaker cuts off the operation frequently.**
- **A switch or a button often fails to work properly.**
- **There is a burning smell.**
- **Water leaks from the indoor unit.**

Turn the breaker OFF and call your authorized dealer.

■ After a power failure

The air conditioner automatically resumes operation in about 3 minutes. You should just wait for a while.

■ Lightning

If lightning may strike the neighboring area, stop operation and turn the breaker OFF for system protection.

Disposal requirements

Dismantling of the unit, treatment of the refrigerant, oil and eventual other parts, should be done in accordance with the relevant local and national regulations. Contact your authorized dealer for assistance.

We recommend periodical maintenance.

In certain operating conditions, the inside of the air conditioner may get foul after several seasons of use, resulting in poor performance. It is recommended to have periodical maintenance by a specialist aside from regular cleaning by the user. For specialist maintenance, contact your authorized dealer where you bought the air conditioner.

The maintenance cost must be born by the user.

Fault diagnosis.

FAULT DIAGNOSIS BY REMOTE CONTROLLER

In the ARC433A series, the temperature display sections on the main unit indicate corresponding codes.

1. When the **TIMER CANCEL** button is held down for 5 seconds, a “00” indication flashes on the temperature display section.

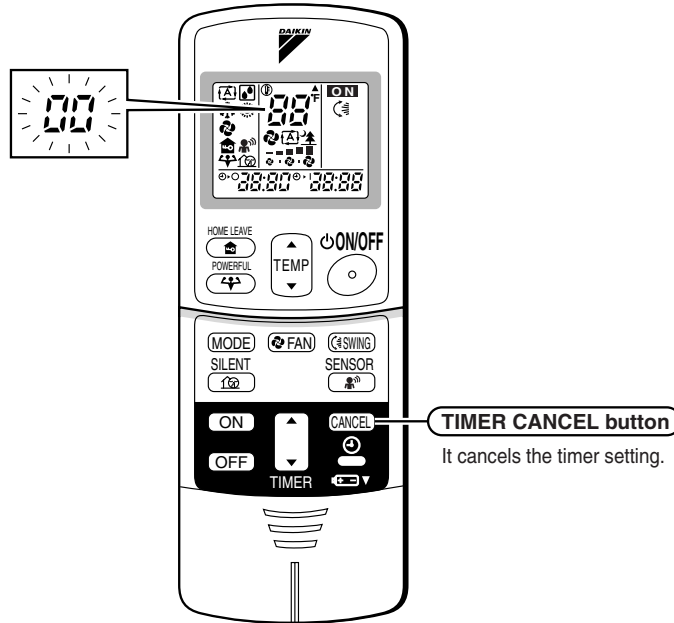

2. Press the **TIMER CANCEL** button repeatedly until a continuous beep is produced.

- The code indication changes as shown below, and notifies with a long beep.

	CODE	MEANING
SYSTEM	00	NORMAL
	U0	REFRIGERANT SHORTAGE
	U2	DROP VOLTAGE OR MAIN CIRCUIT OVERVOLTAGE
	U4	FAILURE OF TRANSMISSION (BETWEEN INDOOR UNIT AND OUTDOOR UNIT)
INDOOR UNIT	A1	INDOOR PCB DEFECTIVENESS
	A5	HIGH PRESSURE CONTROL OR FREEZE-UP PROTECTOR
	A6	FAN MOTOR FAULT
	C4	FAULTY HEAT EXCHANGER TEMPERATURE SENSOR
OUTDOOR UNIT	C9	FAULTY SUCTION AIR TEMPERATURE SENSOR
	EA	COOLING-HEATING SWITCHING ERROR
	E5	OL STARTED
	E6	FAULTY COMPRESSOR START UP
	E7	DC FAN MOTOR FAULT
	E8	OPERATION HALT DUE TO DETECTION OF INPUT OVER CURRENT
	F3	HIGH TEMPERATURE DISCHARGE PIPE CONTROL
	F6	HIGH PRESSURE CONTROL (IN COOLING)
	H6	OPERATION HALT DUE TO FAULTY POSITION DETECTION SENSOR
	H8	CT ABNORMALITY
	H9	FAULTY SUCTION AIR TEMPERATURE SENSOR
	J3	FAULTY DISCHARGE PIPE TEMPERATURE SENSOR
	J6	FAULTY HEAT EXCHANGER TEMPERATURE SENSOR
	L4	HIGH TEMPERATURE AT INVERTER CIRCUIT HEATSINK
L5	OUTPUT OVERCURRENT	
P4	FAULTY INVERTER CIRCUIT HEATSINK TEMPERATURE SENSOR	

NOTE

1. A short beep and two consecutive beeps indicate non-corresponding codes.
2. To cancel the code display, hold the **TIMER CANCEL** button down for 5 seconds. The code display also cancel itself if the button is not pressed for 1 minute.

13.3 The Single Split Duct-Free System FTXS15/18/24DVJU

Names of parts

■ Indoor Unit

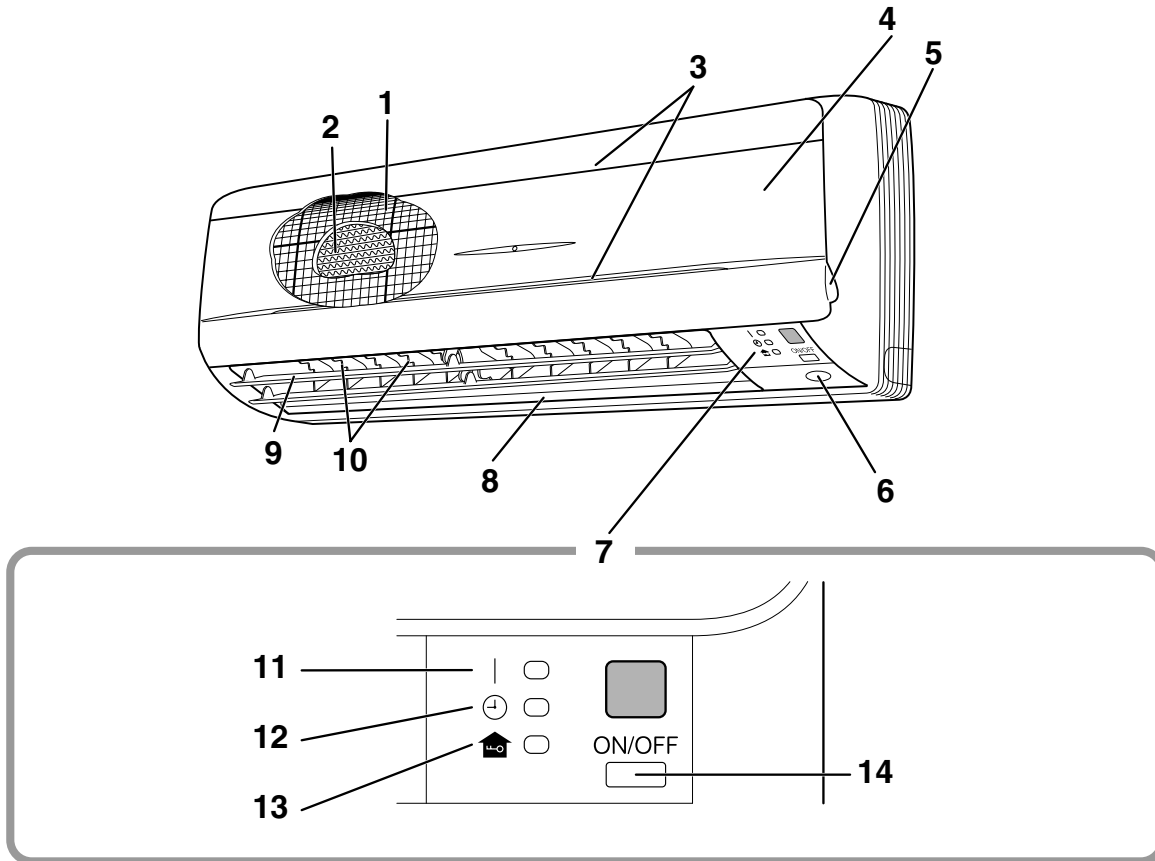

■ Main unit control panel

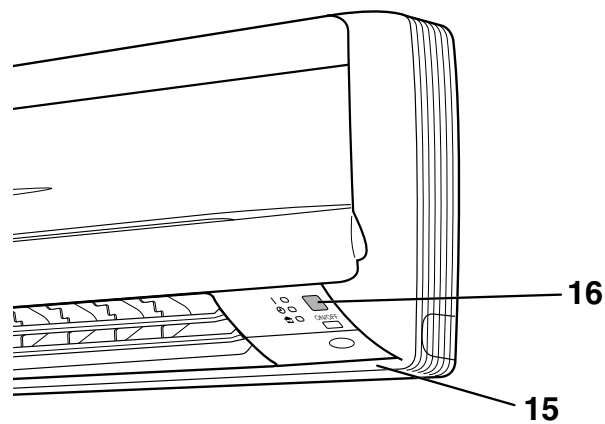

■ Outdoor Unit

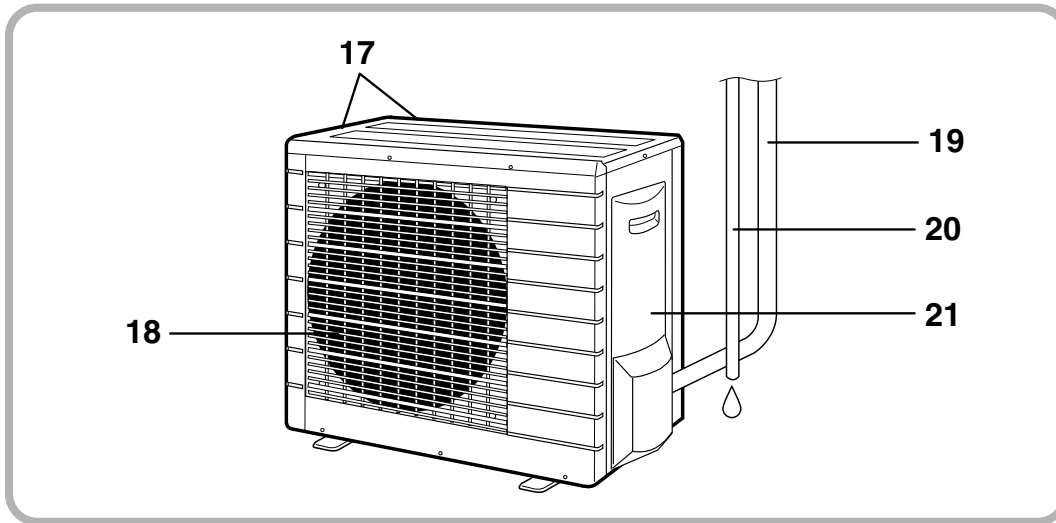

■ Indoor Unit

- 1. Air filter
- 2. Air-purifying filter with photocatalytic deodorizing function:
 - These filters are attached to the inside of the air filters.
- 3. Air inlet
- 4. Front panel
- 5. Panel tab
- 6. INTELLIGENT EYE sensor:
 - It detects the movements of people and automatically switches between normal operation and energy saving operation. (page 18.)
- 7. Display
- 8. Air outlet
- 9. Flaps (horizontal blades): (page 12.)
- 10. Louvers (vertical blades):
 - The louvers are inside of the air outlet. (page 13.)
- 11. Operation lamp (green)
- 12. TIMER lamp (yellow): (page 20.)
- 13. HOME LEAVE lamp (red):
 - Lights up when you use HOME LEAVE Operation. (page 16.)

14. Indoor Unit ON/OFF switch:

- Push this switch once to start operation. Push once again to stop it.
- The operation mode refers to the following table.

Mode	Temperature setting	Airflow rate
AUTO	77°F	AUTO

- This switch is useful when the remote controller is missing.

15. Room temperature sensor:

- It senses the air temperature around the unit.

16. Signal receiver:

- It receives signals from the remote controller.
- When the unit receives a signal, you will hear a short beep.
 - Operation startbeep-beep
 - Settings changedbeep
 - Operation stopbeeeeeep

■ Outdoor Unit

- 17. Air inlet: (Back and side)
- 18. Air outlet
- 19. Refrigerant piping and inter-unit cable
- 20. Drain hose
- 21. Earth grounding terminal:
 - It is inside of this cover.

Appearance of the outdoor unit may differ from some models.

■ Remote Controller

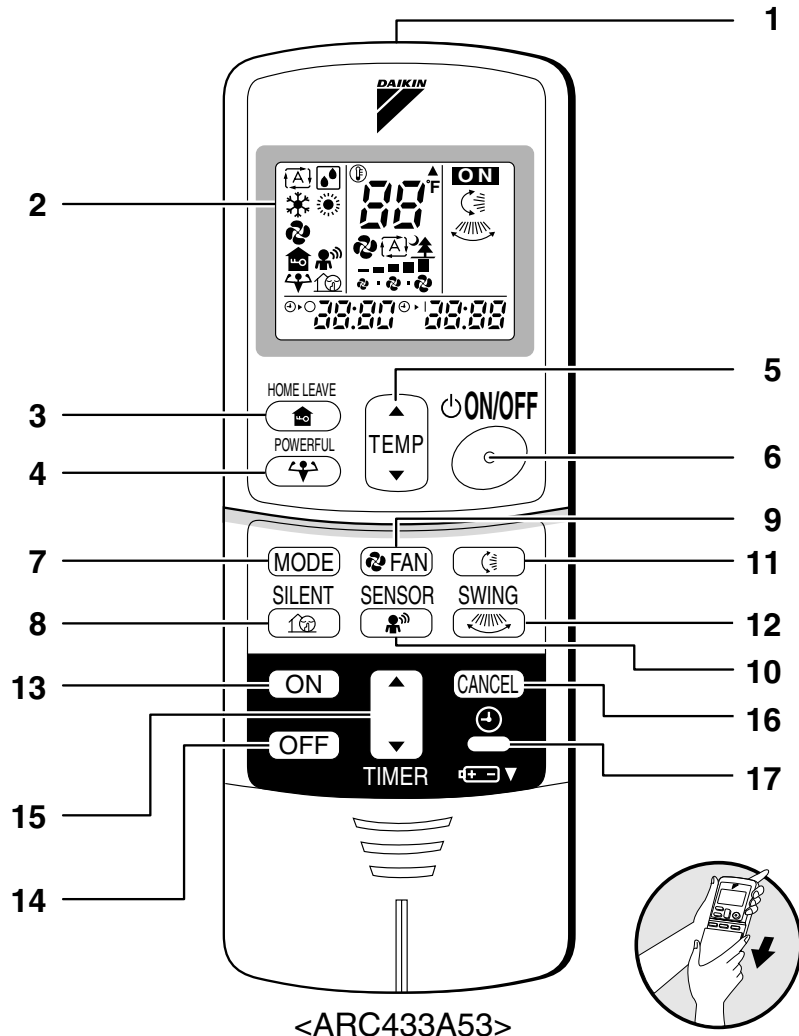

1. Signal transmitter:

- It sends signals to the indoor unit.

2. Display:

- It displays the current settings.
(In this illustration, each section is shown with all its displays ON for the purpose of explanation.)

3. HOME LEAVE button:

- HOME LEAVE operation (page 16.)

4. POWERFUL button: (Maximum operation)

- POWERFUL operation (page 14.)

5. TEMPERATURE adjustment buttons:

- It changes the temperature setting.

6. ON/OFF button:

- Press this button once to start operation.
Press once again to stop it.

7. MODE selector button:

- It selects the operation mode.
(AUTO/DRY/COOL/HEAT/FAN) (page 10.)

8. SILENT button: OUTDOOR UNIT SILENT operation (page 15.)

9. FAN setting button:

- It selects the airflow rate setting.

10. SENSOR button: INTELLIGENT EYE operation (page 18.)

11. SWING button: (page 12.)

- Flap (Horizontal blade)

12. SWING button: (page 12.)

- Louver (Vertical blades)

13. ON TIMER button: (page 21.)

14. OFF TIMER button: (page 20.)

15. TIMER Setting button:

- It changes the time setting.

16. TIMER CANCEL button:

- It cancels the timer setting.

17. CLOCK button: (page 9.)

Preparation Before Operation

■ To set the batteries

1. Slide the front cover to take it off.
2. Set two dry batteries (AAA).
3. Set the front cover as before.

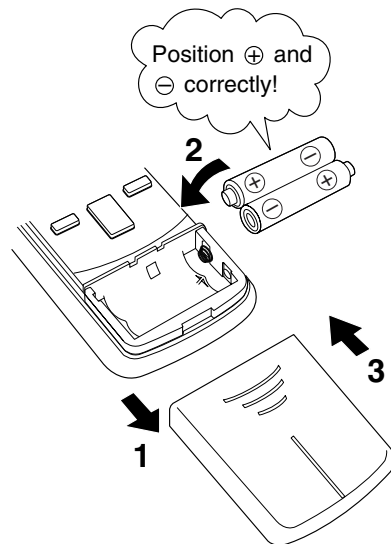

ATTENTION

■ About batteries

- When replacing the batteries, use batteries of the same type, and replace the two old batteries together.
- When the system is not used for a long time, take the batteries out. In case the remote controller is not used for a long time remove all batteries in order to prevent liquid leak of the battery.
- We recommend replacing once a year, although if the remote controller display begins to fade or if reception deteriorates, please replace with new alkali batteries. Using manganese batteries reduces the lifespan.
- The attached batteries are provided for the initial use of the system. The usable period of the batteries may be short depending on the manufactured date of the air conditioner.
- Pressing two or more buttons simultaneously may cause the strange display of the remote controller. The remote controller is not malfunction. In this case take the batteries out and reset them.

■ Replacing the Batteries

- When replacing the battery, remove the old battery, wait one minute, and then insert the new battery.

Preparation Before Operation

■ To operate the remote controller

- To use the remote controller, aim the transmitter at the indoor unit. If there is anything to block signals between the unit and the remote controller, such as a curtain, the unit will not operate.
- Do not drop the remote controller. Do not get it wet.
- The maximum distance for communication is about 23 Ft..

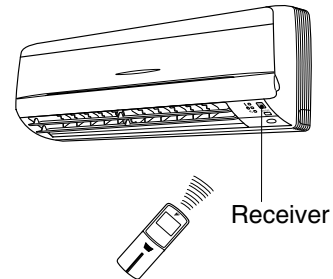

■ To fix the remote controller holder on the wall

1. Choose a place from where the signals reach the unit.
2. Fix the holder to a wall, a pillar, etc. with the screws supplied with the holder.
3. Place the remote controller in the remote controller holder.

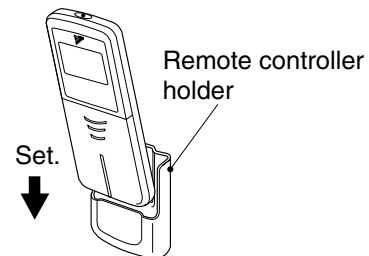

- To remove, pull it upwards.

ATTENTION

■ About remote controller

- Do not put the remote controller in the following places.
 - In direct sunlight.
 - In vicinity of a heater.
- Dust on the signal transmitter or receiver will reduce the sensitivity. Wipe off dust with soft cloth.
- Signal communication may be disabled if an electronic-starter-type fluorescent lamp (such as inverter-type lamps) is in the room. Consult your authorized dealer if that is the case.
- If the remote controller signals happen to operate another appliance, move that appliance to somewhere else, or consult your authorized dealer.

■ **To set the clock**

1. Press “CLOCK button”.

0:00 is displayed.

⌚ blinks.

2. Press “TIMER setting button” to set the clock to the present time.

Holding down “▲” or “▼” button rapidly increases or decreases the time display.

3. Press “CLOCK button”.

⌚ blinks.

■ **Turn the breaker ON**

- Turning ON the breaker opens the flap, then closes it again. (This is a normal procedure.)

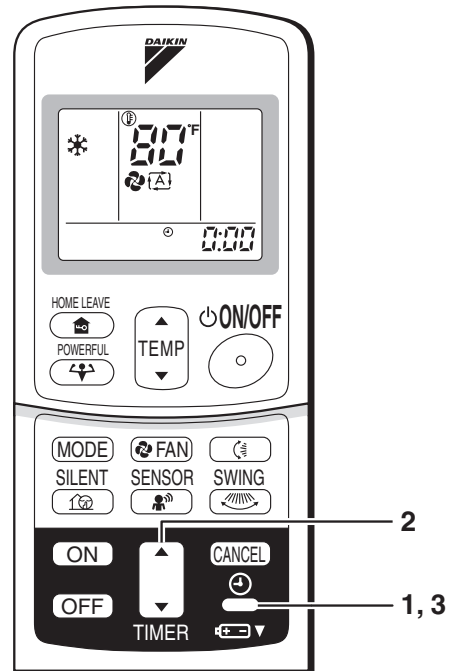

NOTE

■ **Tips for saving energy**

- Be careful not to cool (heat) the room too much. Keeping the temperature setting at a moderate level helps save energy.
- Cover windows with a blind or a curtain. Blocking sunlight and air from outdoors increases the cooling (heating) effect.
- Clogged air filters cause inefficient operation and waste energy. Clean them once every two weeks.

Recommended temperature setting
For cooling: 78°F – 82°F
For heating: 68°F – 75°F

■ **Please note**

- When the main power switch is turned on, some watts of electricity are being used even when the system is not operating.
- If you are not going to use the air conditioner for a long period, for example in spring or autumn, turn the breaker OFF to save energy.
- Use the air conditioner in the following conditions.

Mode	Operating conditions	If operation is continued out of this range
COOL	Outdoor temperature: 14 to 115 °F Indoor temperature: 64 to 90 °F Indoor humidity: 80% max.	<ul style="list-style-type: none"> • A safety device may work to stop the operation under 0 °F and over 115 °F outdoor temperature. • See Note 2 for 0 °F to 14 °F operation. • Condensation may occur on the indoor unit and drip.
HEAT	Outdoor temperature: 5 to 64 °F Indoor temperature: 50 to 86 °F	<ul style="list-style-type: none"> • A safety device may work to stop the operation under 0 °F or over 64 °F outdoor temperature. See the Note 3 for 0 °F to 5 °F.
DRY	Outdoor temperature: 14 to 115 °F Indoor temperature: 64 to 90 °F Indoor humidity: 80% max.	<ul style="list-style-type: none"> • A safety device may work to stop the operation. • Condensation may occur on the indoor unit and drip.

- Operation outside this humidity or temperature range may cause a safety device to disable the system.
- <Note 1> **A Breaker must be turned on for 24 hours before the operation start if the ambient is below 14 °F, otherwise the unit will not start operation smoothly.**
- <Note 2> **1. Use low outdoor ambient cooling operation for equipment cooling applications only. This operation is not intended for human comfort cooling.**
2. Intermittent noises may be produced by the indoor unit due to the outdoor fan rotation speed change.
 3. Do not place humidifiers or other items which might raise the humidity in rooms at 0 to 14 °F outdoor temperature. A humidifier may cause condensation to drip from the indoor unit outlet vent.
 4. Set the indoor unit at the highest air flow rate.
- <Note 3> **When the outdoor temperature is 0 to 5 degrees F, the system may not have sufficient cooling capacity.**

AUTO · DRY · COOL · HEAT · FAN Operation

The air conditioner operates with the operation mode of your choice.
 From the next time on, the air conditioner will operate with the same operation mode.

■ To start operation

1. Press “MODE selector button” and select a operation mode.

- Each pressing of the button advances the mode setting in sequence.

- Ⓐ: AUTO
- ☐: DRY
- ❄: COOL
- ☀: HEAT
- 🌀: FAN



2. Press “ON/OFF button” .

- The OPERATION lamp lights up.

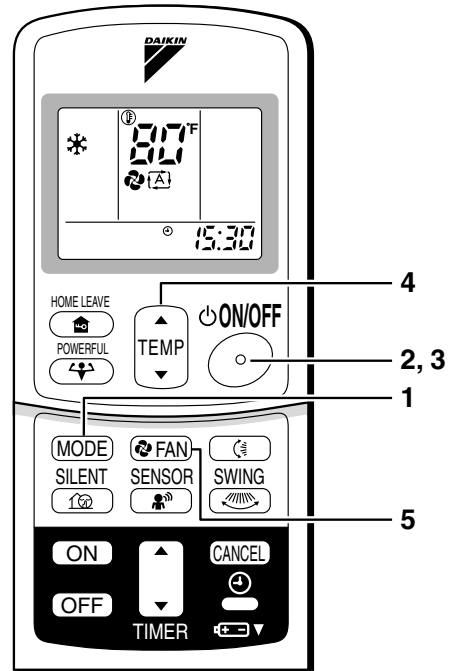
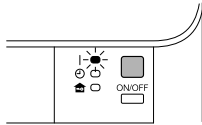

■ To stop operation

3. Press “ON/OFF button” again.

- Then OPERATION lamp goes off.





■ To change the temperature setting

4. Press “TEMPERATURE adjustment button”.

DRY or FAN mode	AUTO or COOL or HEAT mode
The temperature setting is not variable.	Press “▲” to raise the temperature and press “▼” to lower the temperature.
	Set to the temperature you like. 

■ To change the airflow rate setting

5. Press “FAN setting button”.

DRY mode	AUTO or COOL or HEAT or FAN mode
The airflow rate setting is not variable.	Five levels of airflow rate setting from “  ” to “  ” plus “  ” “  ” are available. 

- Indoor unit quiet operation

When the airflow is set to “”, the noise from the indoor unit will become quieter.
Use this when making the indoor unit quieter.

The unit might lose capacity when the airflow rate is set to a low level.

NOTE

■ Note on HEAT operation

- Since this air conditioner heats the room by taking heat from outdoor air to indoors, the heating capacity becomes smaller in lower outdoor temperatures. If the heating effect is insufficient, it is recommended to use another heating appliance in combination with the air conditioner.
- The heat pump system heats the room by circulating hot air around all parts of the room. After the start of heating operation, it takes some time before the room gets warmer.
- In heating operation, frost may occur on the outdoor unit and lower the heating capacity. In that case, the system switches into defrosting operation to take away the frost.
- During defrosting operation, hot air does not flow out of indoor unit.

■ Note on COOL operation

- This air conditioner cools the room by blowing the hot air in the room outside, so if the outside temperature is high, performance drops.

■ Note on DRY operation

- The computer chip works to rid the room of humidity while maintaining the temperature as much as possible. It automatically controls temperature and fan strength, so manual adjustment of these functions is unavailable.

■ Note on AUTO operation

- In AUTO operation, the system selects an appropriate operation mode (COOL or HEAT) based on the room temperature at the start of the operation.
- The system automatically reselects setting at a regular interval to bring the room temperature to user-setting level.
- If you do not like AUTO operation, you can manually select the operation mode and setting you like.



■ Note on airflow rate setting

- At smaller airflow rates, the cooling (heating) effect is also less.

Adjusting the Airflow Direction



You can adjust the airflow direction to increase your comfort.

■ To adjust the horizontal blade (flap)

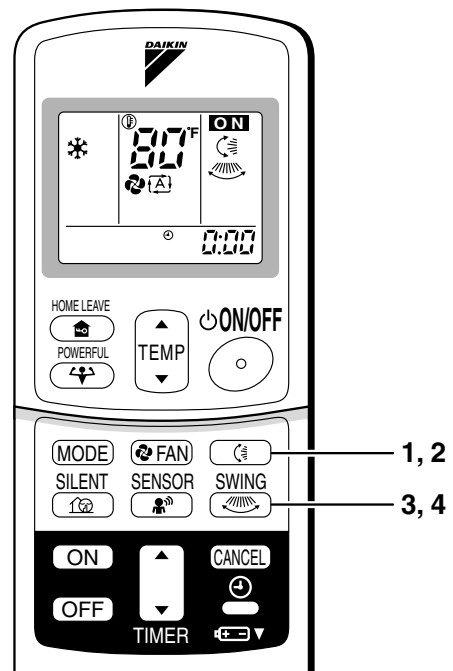



1. Press “SWING button ”.
 - “” is displayed on the LCD.
2. When the flap has reached the desired position, press “SWING button ” once more.
 - The flap will stop moving.



■ To adjust the vertical blades (louvers)

3. Press “SWING button ”.
 - “” is displayed on the LCD.
4. When the louvers have reached the desired position, press the “SWING button ” once more.
 - The louvers will stop moving.

■ To 3-D Airflow

Press the “SWING button ” and the “SWING button ”:
 the “” and “” display will light up and the flap and louvers will move in turn.
 (page 12.)

■ To cancel 3-D Airflow

Press either the “SWING button ” or the “SWING button ”. (page 12.)

Notes on louvers angles

■ ATTENTION

- Always use a remote controller to adjust the louvers angles. In side the air outlet, a fan is rotating at a high speed and may cause bodily injury if fan comes in contact with fingers.

Notes on flaps angles

- When “SWING button” is selected, the flaps swinging range depends on the operation mode. (See the figure.)

Three-Dimensional (3-D) Airflow

- Using three-dimensional airflow circulates cold air, which tends to collected at the bottom of the room, and hot air, which tends to collect near the ceiling, throughout the room, preventing areas of cold and hot developing.

■ ATTENTION

- Always use a remote controller to adjust the flaps angle. If you attempt to move it forcibly with hand when it is swinging, the mechanism may be broken.
- Be careful when adjusting the louvers. Inside the air outlet, fan is rotating at a high speed and may cause bodily injury if fan comes in contact with fingers.

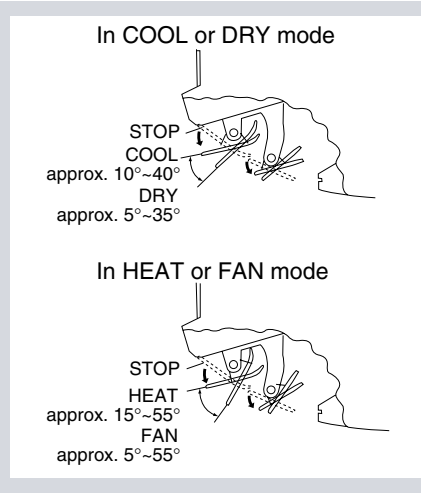

POWERFUL Operation

POWERFUL operation quickly maximizes the cooling (heating) effect in any operation mode. You can get the maximum capacity.

■ To start POWERFUL operation

1. Press “POWERFUL button”.

- POWERFUL operation ends in 20 minutes. Then the system automatically operates again with the settings which were used before POWERFUL operation.
- When using POWERFUL operation, there are some functions which are not available.
- “” is displayed on the LCD.

■ To cancel POWERFUL operation

2. Press “POWERFUL button” again.

- “” disappears from the LCD.

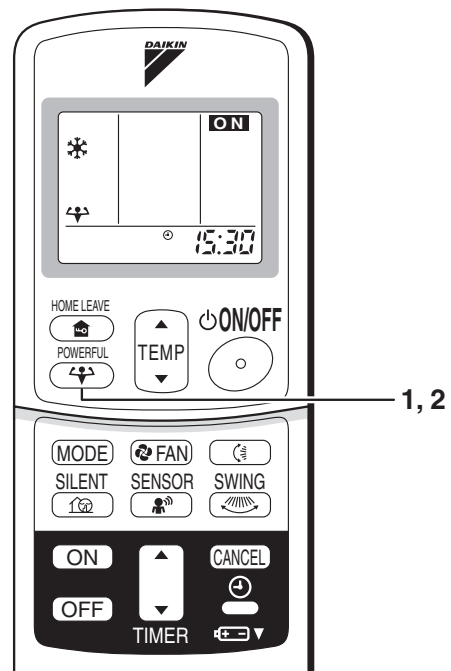

NOTE

■ Notes on POWERFUL operation

- POWERFUL Operation cannot be used together with SILENT Operation. Priority is given to the function of whichever button is pressed last.
- POWERFUL Operation can only be set when the unit is running. Pressing the operation stop button causes the settings to be canceled, and the “” disappears from the LCD.
- **In COOL and HEAT mode**
To maximize the cooling (heating) effect, the capacity of outdoor unit must be increased and the airflow rate be fixed to the maximum setting.
The temperature and airflow settings are not variable.
- **In DRY mode**
The temperature setting is lowered by 4.5°F and the airflow rate is slightly increased.
- **In FAN mode**
The airflow rate is fixed to the maximum setting.

OUTDOOR UNIT SILENT Operation

OUTDOOR UNIT SILENT operation lowers the noise level of the outdoor unit by changing the fan speed on the outdoor unit. This function is convenient during night.

■ To start OUTDOOR UNIT SILENT operation

1. Press “SILENT button”.
 - “” is displayed on the LCD.

■ To cancel OUTDOOR UNIT SILENT operation

2. Press “SILENT button” again.
 - “” disappears from the LCD.

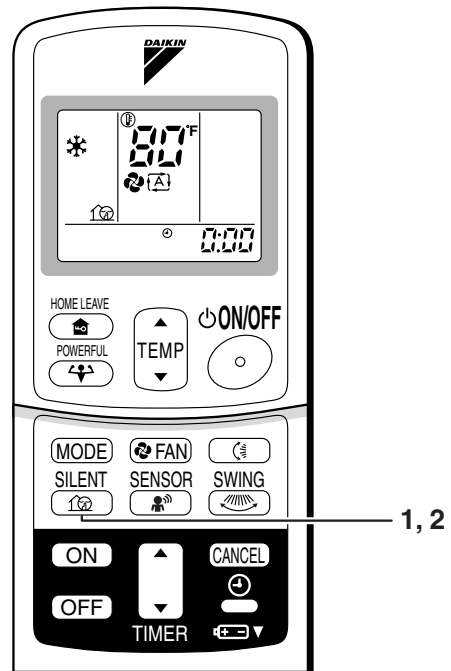

NOTE

■ Note on OUTDOOR UNIT SILENT operation

- This function is available in COOL, HEAT, and AUTO modes. (This is not available in FAN and DRY modes.)
- POWERFUL operation and OUTDOOR UNIT SILENT operation cannot be used at the same time. Priority is given to the function of whichever button is pressed last.
- If operation is stopped using the remote controller or the main unit ON/OFF switch when using OUTDOOR UNIT SILENT operation, “” will remain on the remote controller display.

HOME LEAVE Operation

HOME LEAVE operation is a function which allows you to record your preferred temperature and airflow rate settings.

■ To start HOME LEAVE operation

1. Press “HOME LEAVE button” .

- “” is displayed on the LCD.
- The HOME LEAVE lamp lights up.

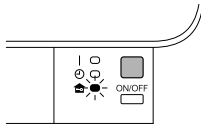

■ To cancel HOME LEAVE operation

2. Press “HOME LEAVE button” again.

- “” disappears from the LCD.
- The HOME LEAVE lamp goes off.

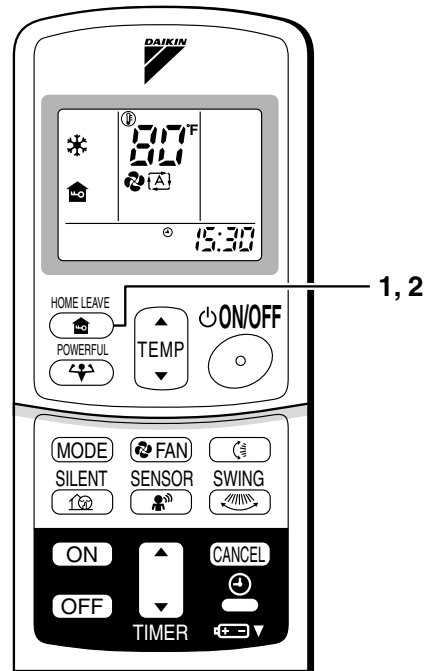

Before using HOME LEAVE operation.

■ To set the temperature and airflow rate for HOME LEAVE operation

When using HOME LEAVE operation for the first time, please set the temperature and airflow rate for HOME LEAVE operation. Record your preferred temperature and airflow rate.

	Initial setting		Selectable range	
	Temperature	Airflow rate	Temperature	Airflow rate
Cooling	77°F	AUTO	64-90°F	5 step, AUTO and SILENT
Heating	77°F	AUTO	50-86°F	5 step, AUTO and SILENT

1. Press “HOME LEAVE button”. Make sure “” is displayed in the remote controller display.
2. Adjust the set temperature with “▲” or “▼” as you like.
3. Adjust the airflow rate with “FAN” setting button as you like.

Home leave operation will run with these settings the next time you use the unit. To change the recorded information, repeat steps 1 – 3.

■ What's the HOME LEAVE operation?

Is there a set temperature and airflow rate which is most comfortable, a set temperature and airflow rate which you use the most? HOME LEAVE operation is a function that allows you to record your favorite set temperature and airflow rate. You can start your favorite operation mode simply by pressing the HOME LEAVE button on the remote controller. This function is convenient in the following situations.

■ Useful in these cases

1. Use as an energy-saving mode.

Set the temperature 3-5°F higher (cooling) or lower (heating) than normal. Setting the fan speed to the lowest setting allows the unit to be used in energy-saving mode. Also convenient for use while you are out or sleeping.

• Every day before you leave the house...

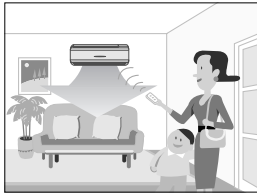

When you go out, push the "HOME LEAVE Operation" button, and the air conditioner will adjust capacity to reach the preset temperature for HOME LEAVE Operation.

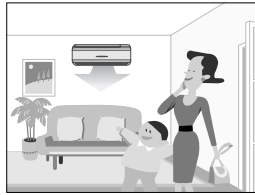

When you return, you will be welcomed by a comfortably air conditioned room.

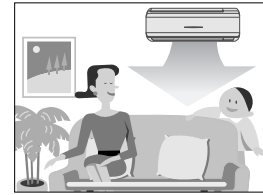

Push the "HOME LEAVE Operation" button again, and the air conditioner will adjust capacity to the set temperature for normal operation.

• Before bed...

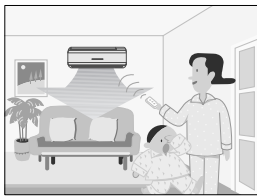

Set the unit to HOME LEAVE Operation before leaving the living room when going to bed.

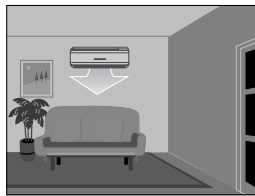

The unit will maintain the temperature in the room at a comfortable level while you sleep.

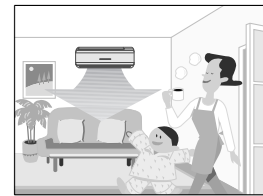

When you enter the living room in the morning, the temperature will be just right. Disengaging HOME LEAVE Operation will return the temperature to that set for normal operation. Even the coldest winters will pose no problem!

2. Use as a favorite mode

Once you record the temperature and airflow rate settings you most often use, you can retrieve them by pressing HOME LEAVE button. You do not have to go through troublesome remote controller operations.

NOTE

- Once the temperature and airflow rate for HOME LEAVE operation are set, those settings will be used whenever HOME LEAVE operation is used in the future. To change these settings, please refer to the "Before using HOME LEAVE operation" section above.
- HOME LEAVE operation is only available in COOL and HEAT mode. It cannot be used in AUTO, DRY, and FAN mode.
- HOME LEAVE operation runs in accordance with the previous operation mode (COOL or HEAT) before using HOME LEAVE operation.
- HOME LEAVE operation and POWERFUL operation cannot be used at the same time. Last button that was pressed has priority.
- The operation mode cannot be changed while HOME LEAVE operation is being used.
- When operation is shut off during HOME LEAVE operation, using the remote controller or the indoor unit ON/OFF switch, "🏠" will remain on the remote controller display.

INTELLIGENT EYE Operation

“INTELLIGENT EYE” is the infrared sensor which detects the human movement.

■ To start INTELLIGENT EYE operation

1. Press “SENSOR button”.
 - “” is displayed on the LCD.

■ To cancel the INTELLIGENT EYE operation

2. Press “SENSOR button” again.
 - “” disappears from the LCD.

[EX.]

When somebody is in the room

- Normal operation.



When nobody is in the room

- 20 min. after, start energy saving operation.



When somebody is back in the room

- Back to normal operation.

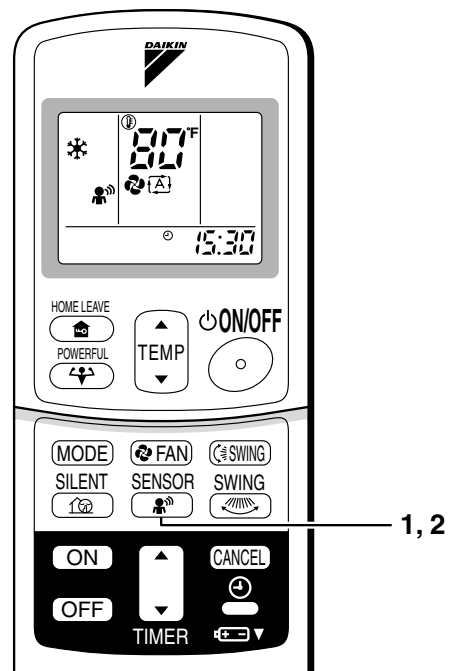

“INTELLIGENT EYE” is useful for Energy Saving

■ Energy saving operation

- Change the temperature -3.6°F in heating / $+3.6^{\circ}\text{F}$ in cooling / $+1.8^{\circ}\text{F}$ in dry mode from set temperature.
- Decrease the airflow rate slightly in fan operation. (In FAN mode only)

Notes on “INTELLIGENT EYE”

- Application range is as follows.

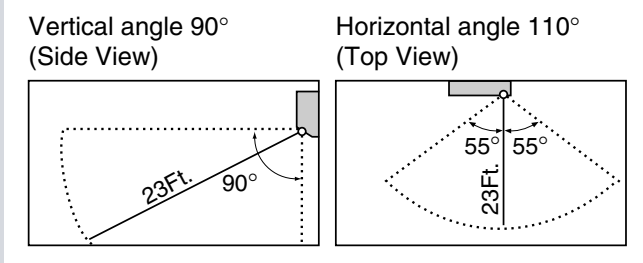

- Sensor may not detect moving objects further than 23Ft. away. (Check the application range)
- Sensor detection sensitivity changes according to indoor unit location, the speed of passersby, temperature range, etc.
- The sensor also mistakenly detects pets, sunlight, fluttering curtains and light reflected off of mirrors as passersby.
- INTELLIGENT EYE operation will not go on during powerful operation.
- Night set mode (page 20.) will not go on during your use of INTELLIGENT EYE operation.

⚠ CAUTION

- Do not place large objects near the sensor. Also keep heating units or humidifiers outside the sensor’s detection area. This sensor can detect objects it shouldn’t as well as not detect objects it should.
- Do not hit or violently push the INTELLIGENT EYE sensor. This can lead to damage and malfunction.

TIMER Operation

Timer functions are useful for automatically switching the air conditioner on or off at night or in the morning. You can also use OFF TIMER and ON TIMER in combination.

■ To use OFF TIMER operation

- Check that the clock is correct.
If not, set the clock to the present time. (page 9.)

1. Press “OFF TIMER button”.

0:00 is displayed.

⊖○ blinks.

2. Press “TIMER Setting button” until the time setting reaches the point you like.

- Every pressing of either button increases or decreases the time setting by 10 minutes. Holding down either button changes the setting rapidly.

3. Press “OFF TIMER button” again.

- The TIMER lamp lights up.

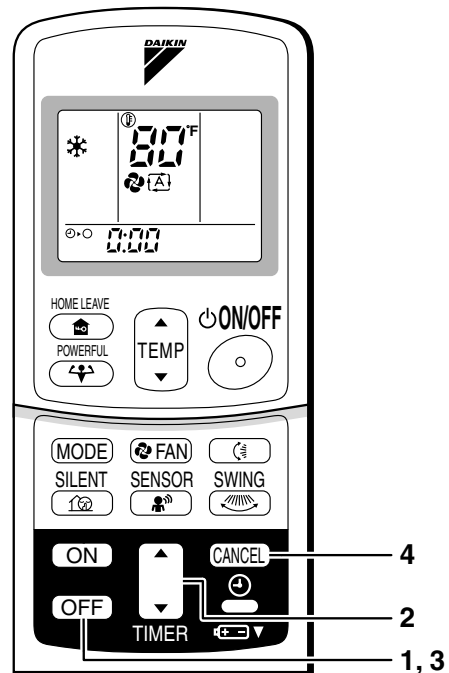
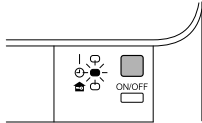

■ To cancel the OFF TIMER operation

4. Press “CANCEL button”.

- The TIMER lamp goes off.

NOTE

- When TIMER is set, the present time is not displayed.
- Once you set ON, OFF TIMER, the time setting is kept in the memory. (The memory is lost when remote controller batteries are replaced.)
- When operating the unit via the ON/OFF Timer, the actual length of operation may vary from the time entered by the user.

■ NIGHT SET MODE

When the OFF TIMER is set, the air conditioner automatically adjusts the temperature setting (1°F up in COOL, 3.6°F down in HEAT) to prevent excessive cooling (heating) for your pleasant sleep.

■ To use ON TIMER operation

- Check that the clock is correct. If not, set the clock to the present time. (page 9.)

1. Press “ON TIMER button”.

6:00 is displayed.

⊕/⊖ blinks.

2. Press “TIMER Setting button” until the time setting reaches the point you like.

- Every pressing of either button increases or decreases the time setting by 10 minutes. Holding down either button changes the setting rapidly.

3. Press “ON TIMER button” again.

- The TIMER lamp lights up.

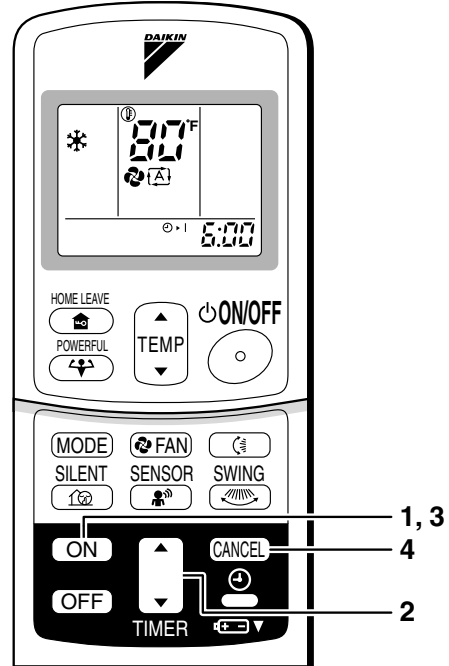
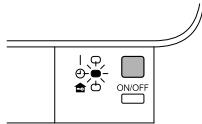

■ To cancel ON TIMER operation

4. Press “CANCEL button”.

- The TIMER lamp goes off.

■ To combine ON TIMER and OFF TIMER

- A sample setting for combining the two timers is shown below.

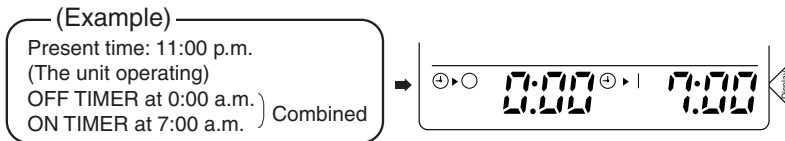

ATTENTION

■ In the following cases, set the timer again.

- After a breaker has turned OFF.
- After a power failure.
- After replacing batteries in the remote controller.

Care and Cleaning

⚠ CAUTION Before cleaning, be sure to stop the operation and turn the breaker OFF.

Units

To avoid possible bodily injury, units should be shutoff or disconnected before any cleaning or servicing is attempted.

■ Indoor unit, Outdoor unit and Remote controller

1. Wipe them with dry soft cloth.

■ Front panel

1. Open the front panel.

- Hold the panel by the tabs on the two sides and lift it until it stops with a click.

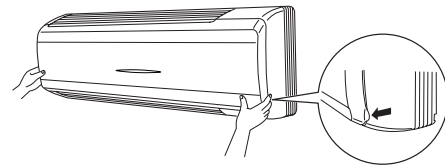

2. Remove the front panel.

- Open the front panel further while sliding it to either the left or right and pulling it toward you. This will disconnect the rotation dowel on one side. Then disconnect the rotation dowel on the other side in the same manner.

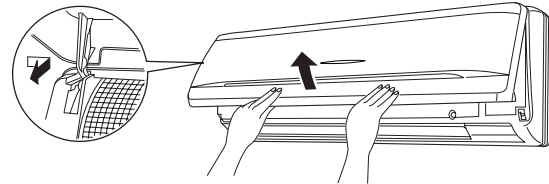

3. Clean the front panel.

- Wipe it with a soft cloth soaked in water.
- Only neutral detergent may be used.
- In case of washing the panel with water, dry it with cloth, dry it up in the shade after washing.

4. Attach the front panel.

- Align the rotation dowels on the left and right of the front panel with the slots, then push them all the way in.
- Close the front panel slowly. (Press the panel at both sides and the center.)

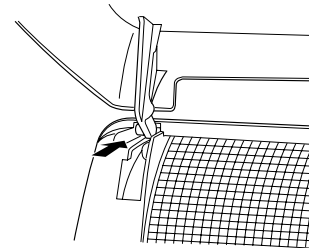

⚠ CAUTION

- Don't touch the metal parts of the indoor unit. If you touch those parts, this may cause an injury.
- When removing or attaching the front panel, use a robust and stable stool and watch your steps carefully.
- When removing or attaching the front panel, support the panel securely with hand to prevent it from falling.
- For cleaning, do not use hot water above 104°F, benzene, gasoline, thinner, nor other volatile oils, polishing compound, scrubbing brushes, nor other hand stuff.
- After cleaning, make sure that the front panel is securely fixed.

Filters

1. **Open the front panel. (page 22.)**

2. **Pull out the air filters.**

- Push a little upwards the tab at the center of each air filter, then pull it down.

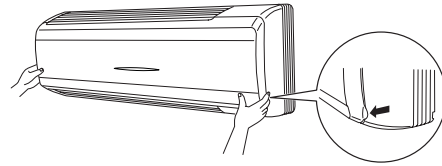

3. **Take off the air-purifying filter with photocatalytic deodorizing function.**

- Press the top of the air-cleaning filter onto the tabs (3 at top). Then press the bottom of the filter up slightly, and press it onto the tabs (3 at bottom).

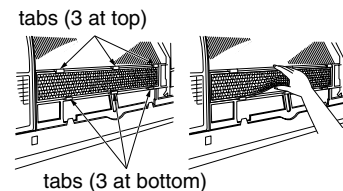
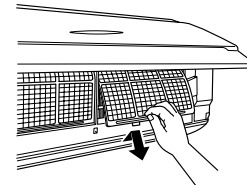

4. **Clean or replace each filter.**

See figure.

5. **Set the air filter and the air-purifying filter with photocatalytic deodorizing function as they were and close the front panel.**

- Press the front panel at both sides and the center.

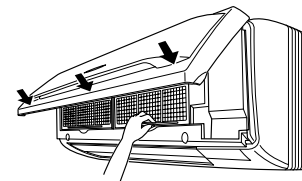

■ **Air Filter**

1. **Wash the air filters with water or clean them with vacuum cleaner.**

- If the dust does not come off easily, wash them with neutral detergent thinned with lukewarm water, then dry them up in the shade.
- It is recommended to clean the air filters every two weeks.

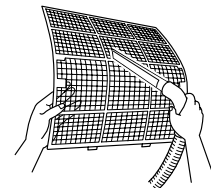

■ **Air-purifying filter with photocatalytic deodorizing function (gray)**

The Air-purifying filter with photocatalytic deodorizing function can be renewed by washing it with water once every 6 months. We recommend replacing it once every 3 years.

[Maintenance]

1. **Remove dust with a vacuum cleaner and wash lightly with water.**
2. **If it is very dirty, soak it for 10 to 15 minutes in water mixed with a neutral cleaning agent.**
3. **After washing, shake off remaining water and dry in the shade.**
4. **Since the material is made out of paper, do not wring out the filter when removing water from it.**

[Replacement]

1. **Remove the tabs on the filter frame and replace with a new filter.**
 - Dispose of the old filter as flammable waste.

Check

Check that the base, stand and other fittings of the outdoor unit are not decayed or corroded. Check the units to ensure they are level and secure.

Check that nothing blocks the air inlets and the outlets of the indoor unit and the outdoor unit.

Check that the water drains smoothly out of the drain hose during COOL or DRY operation.

- If no drain water is seen, water may be leaking from the indoor unit. Stop operation and consult your authorized dealer.

■ Before a long idle period

1. Operate the “FAN only” for several hours on a warm day to dry out the inside.
 - Press “MODE selector button” and select “FAN” operation.
 - Press “ON/OFF button” and start operation.
2. After operation stops, turn off the electrical circuit breaker for the room air conditioner.
3. Remove and clean the air filters. Reinstall filters after cleaning.
4. Take out batteries from the remote controller.

NOTE

- Operation with dirty filters:
 - (1) cannot deodorize the air.
 - (2) cannot clean the air.
 - (3) results in poor heating or cooling.
 - (4) may cause odor.
- To order air-purifying filter with photocatalytic deodorizing function, contact your authorized dealer where you bought the air conditioner.
- Dispose of old filters as required by local codes.

Item	Part No.
Air-purifying filter with photocatalytic deodorizing function. (without frame) 1 set	KAF952A42

Trouble Shooting

Conditions that appear to be abnormal but are not operational problems.

The following cases are not abnormal problems and you may just continue using it.

Case	Explanation
Operation does not start quickly. <ul style="list-style-type: none"> • When ON/OFF button was pressed soon after operation was stopped. • When the mode was reselected. 	<ul style="list-style-type: none"> • This is to protect the air conditioner. You should wait for about 3 minutes.
Hot air does not flow out soon after the start of heating operation.	<ul style="list-style-type: none"> • The air conditioner is warming up. You should wait for 1 to 4 minutes. (The system is designed to start discharging air only after it has reached a certain temperature.)
The heating operation stops suddenly and a flowing sound is heard.	<ul style="list-style-type: none"> • The system is taking away the frost on the outdoor unit. You should wait for about 3 to 8 minutes.
The outdoor unit emits water or steam.	<ul style="list-style-type: none"> ■ In HEAT mode <ul style="list-style-type: none"> • The frost on the outdoor unit melts into water or steam when the air conditioner is in defrost operation. ■ In COOL or DRY mode <ul style="list-style-type: none"> • Moisture in the air condenses into water on the cool surface of outdoor unit piping and drips.
Mists come out of the indoor unit.	<ul style="list-style-type: none"> ■ This happens when the air in the room is cooled into mist by the cold airflow during cooling operation.
The indoor unit gives out odor.	<ul style="list-style-type: none"> ■ This happens when smells of the room, furniture, or cigarettes are absorbed into the unit and discharged with the airflow. (If this happens, we recommend you to have the indoor unit washed by a technician. Consult your authorized dealer where you bought the air conditioner.)
The outdoor fan rotates while the air conditioner is not in operation.	<ul style="list-style-type: none"> ■ After operation is stopped: <ul style="list-style-type: none"> • The outdoor fan continues rotating for another 60 seconds for system protection. ■ While the air conditioner is not in operation: <ul style="list-style-type: none"> • When the outdoor temperature is very high, the outdoor fan starts rotating for system protection.
The operation stopped suddenly. (OPERATION lamp is on.)	<ul style="list-style-type: none"> ■ For system protection, the air conditioner may stop operating on a sudden large voltage fluctuation. It automatically resumes operation in about 3 minutes.

Check again.

Please check again before calling a repair person.

Case	Check
The air conditioner does not operate. (OPERATION lamp is off.)	<ul style="list-style-type: none"> • Has a breaker been turned OFF or a fuse blown? • Is there a power failure? • Are fresh batteries installed in the remote controller? • Is the timer setting correct?
Cooling (Heating) effect is poor.	<ul style="list-style-type: none"> • Are the air filters clean? • Is anything blocking the air inlet or the outlet of the indoor and the outdoor units? • Is the temperature setting appropriate? • Are the windows and doors closed? • Are the airflow rate and the air direction set appropriately?
Operation stops suddenly. (OPERATION lamp flashes.)	<ul style="list-style-type: none"> • Are the air filters clean? • Is there anything blocking the air inlet or the outlet of the indoor and the outdoor units? <p>Turn the electrical breaker off, clean the air filters or remove obstacles away from inlet and outlet. Then turn the breaker ON again and try operating the air conditioner with the remote controller. If the lamp still blinks, call your authorized dealer where you bought the air conditioner.</p>
An abnormal functioning happens during operation.	<ul style="list-style-type: none"> • The air conditioner may malfunction with lightning or radio waves. Turn the circuit breaker OFF, to reset unit. Then turn it ON again and try operating the air conditioner with the remote controller.

Call your authorized dealer immediately.

 **WARNING**

- When an abnormality (such as a burning smell) occurs, stop operation and turn the circuit breaker OFF. Continued operation in an abnormal condition may result in troubles, electric shocks or fire. Consult your authorized dealer where you bought the air conditioner.
- Do not attempt to repair or modify the air conditioner by yourself. Work performed by untrained persons could result in electric shocks, personal injury, fire, or additional damage to equipment. Consult your authorized dealer where you bought the air conditioner.

If one of the following symptoms takes place, call your authorized dealer immediately.

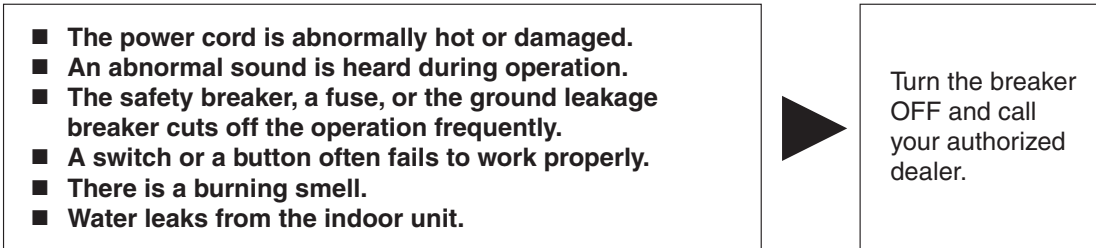

<ul style="list-style-type: none"> ■ After a power failure The air conditioner automatically resumes operation in about 3 minutes. You should just wait for a while. 	<ul style="list-style-type: none"> ■ Lightning If lightning may strike the neighboring area, stop operation and turn the breaker OFF for system protection.
---	--

Disposal requirements

Dismantling of the unit, treatment of the refrigerant, oil and eventual other parts, should be done in accordance with the relevant local and national regulations. Contact your authorized dealer for assistance.

We recommend periodical maintenance.

In certain operating conditions, the inside of the air conditioner may get foul after several seasons of use, resulting in poor performance. It is recommended to have periodical maintenance by a specialist aside from regular cleaning by the user. For specialist maintenance, contact your authorized dealer where you bought the air conditioner.

The maintenance cost must be born by the user.

Fault diagnosis.

FAULT DIAGNOSIS BY REMOTE CONTROLLER

In the ARC433A series, the temperature display sections on the main unit indicate corresponding codes.

1. When the **TIMER CANCEL** button is held down for 5 seconds, a “00” indication flashes on the temperature display section.

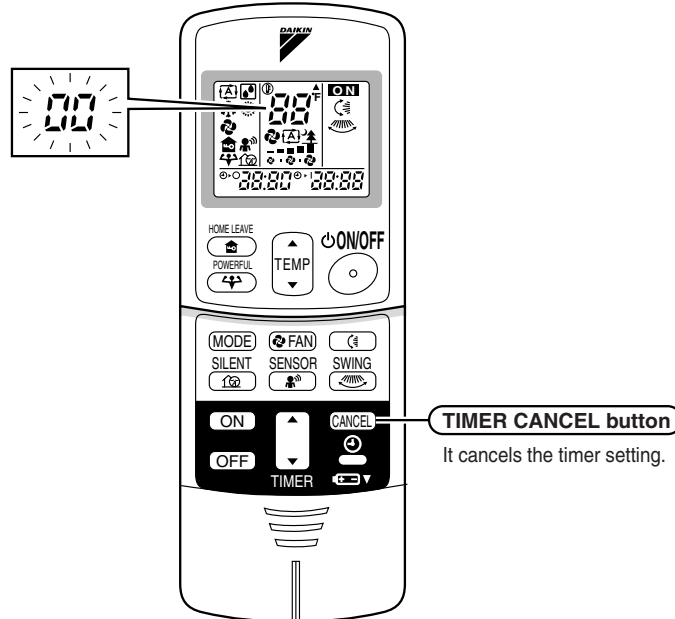

2. Press the **TIMER CANCEL** button repeatedly until a continuous beep is produced.

- The code indication changes as shown below, and notifies with a long beep.

	CODE	MEANING
SYSTEM	00	NORMAL
	U0	REFRIGERANT SHORTAGE
	U2	DROP VOLTAGE OR MAIN CIRCUIT OVERVOLTAGE
	U4	FAILURE OF TRANSMISSION (BETWEEN INDOOR UNIT AND OUTDOOR UNIT)
INDOOR UNIT	A1	INDOOR PCB DEFECTIVENESS
	A5	HIGH PRESSURE CONTROL OR FREEZE-UP PROTECTOR
	A6	FAN MOTOR FAULT
	C4	FAULTY HEAT EXCHANGER TEMPERATURE SENSOR
	C9	FAULTY SUCTION AIR TEMPERATURE SENSOR
OUTDOOR UNIT	EA	COOLING-HEATING SWITCHING ERROR
	E5	OL STARTED
	E6	FAULTY COMPRESSOR START UP
	E7	DC FAN MOTOR FAULT
	E8	OPERATION HALT DUE TO DETECTION OF INPUT OVER CURRENT
	F3	HIGH TEMPERATURE DISCHARGE PIPE CONTROL
	H6	OPERATION HALT DUE TO FAULTY POSITION DETECTION SENSOR
	H8	CT ABNORMALITY
	H9	FAULTY SUCTION AIR TEMPERATURE SENSOR
	J3	FAULTY DISCHARGE PIPE TEMPERATURE SENSOR
	J6	FAULTY HEAT EXCHANGER TEMPERATURE SENSOR
	L4	HIGH TEMPERATURE AT INVERTER CIRCUIT HEATSINK
	L5	OUTPUT OVERCURRENT
P4	FAULTY INVERTER CIRCUIT HEATSINK TEMPERATURE SENSOR	

NOTE

1. A short beep and two consecutive beeps indicate non-corresponding codes.
2. To cancel the code display, hold the **TIMER CANCEL** button down for 5 seconds. The code display also cancel itself if the button is not pressed for 1 minute.

13.4 The Slim Duct Built-in System FDXS09/12DVJU

Names of parts

■ Indoor Unit

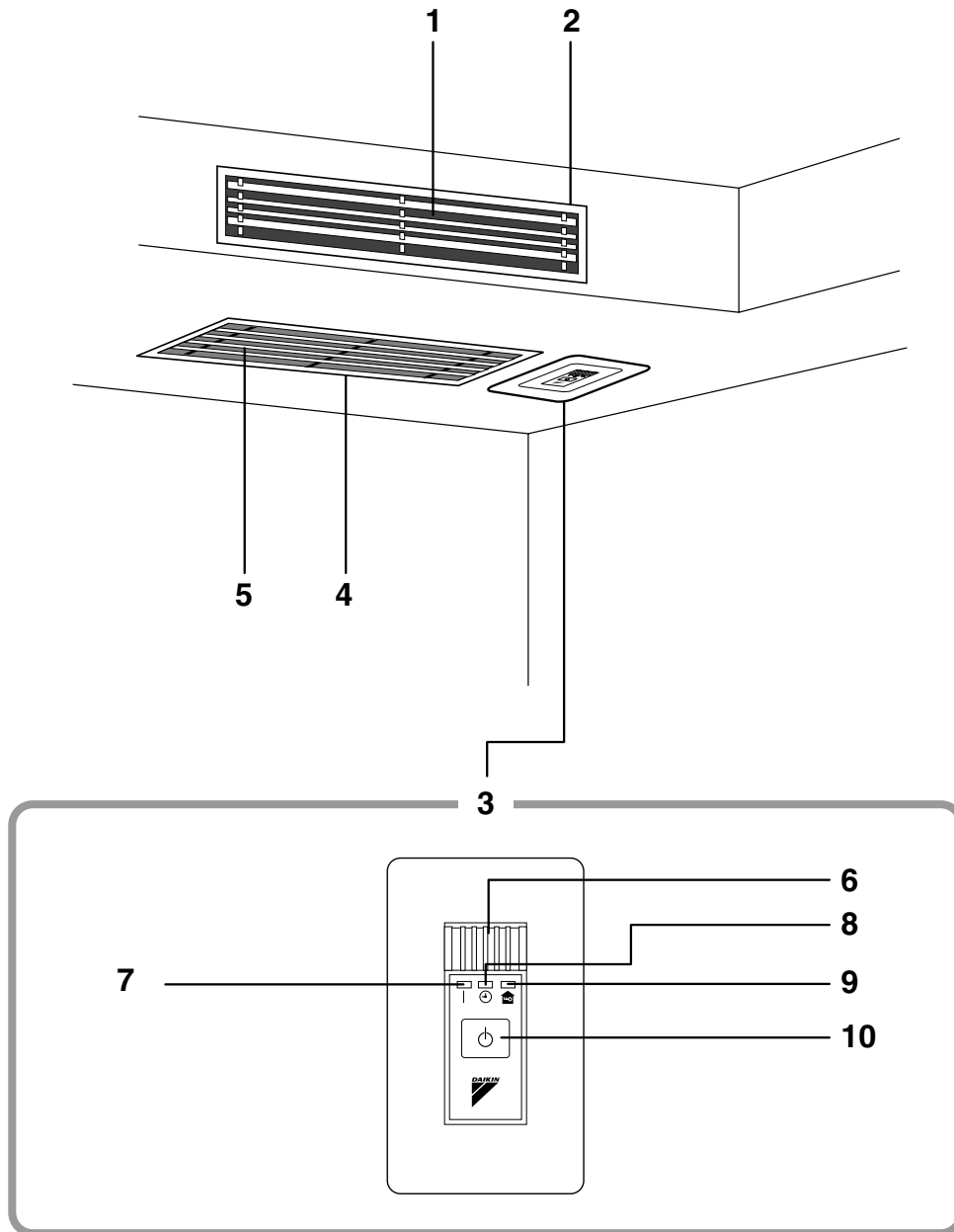

■ Outdoor Unit

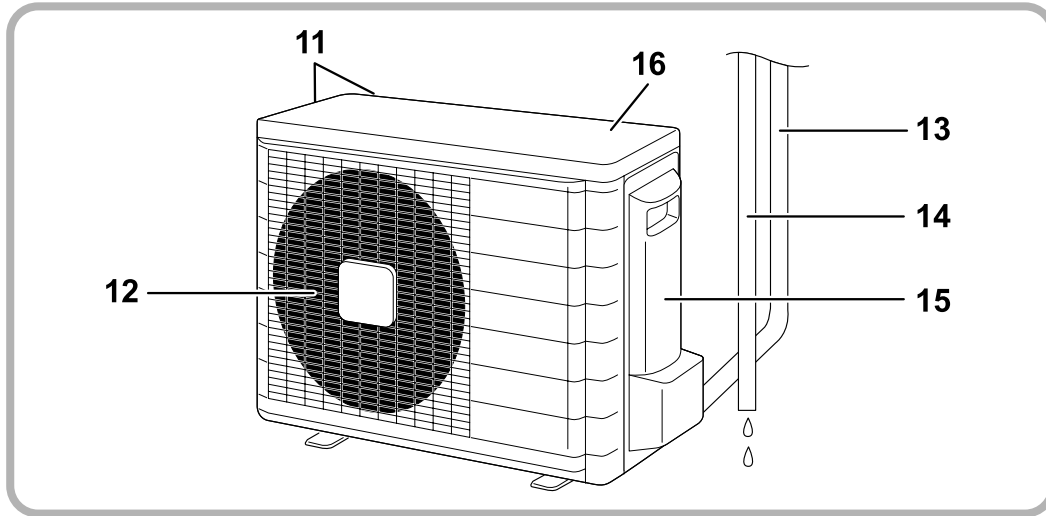

■ Indoor Unit

- 1. Air outlet
- 2. Air outlet grille: (Field supply)
 - Appearance of the Air outlet grille and Air inlet grille may differ with some models.
- 3. Receiver
- 4. Suction grille: (Option)
 - Appearance of the suction grille and Air inlet grille may differ with some models.
- 5. Air inlet
- 6. Room temperature sensor:
 - It senses the air temperature around the unit.
- 7. Operation lamp (green)

- 8. **TIMER lamp (yellow):** (page 16.)
- 9. **HOME LEAVE lamp (red):**
 - Lights up when you use HOME LEAVE operation. (page 14.)
- 10. **Indoor Unit ON/OFF switch:**
 - Push this switch once to start operation. Push once again to stop it.
 - This switch is useful when the remote controller is missing.
- **The operation mode refers to the following table.**

Mode	Temperature setting	Air flow rate
AUTO	77°F	AUTO

■ Outdoor Unit

- 11. Air inlet: (Back and side)
- 12. Air outlet
- 13. Refrigerant piping and inter-unit cable
- 14. Drain hose
- 15. **Earth grounding terminal:**
 - It is inside of this cover.
- 16. **Outside air temperature sensor:**
 - It senses the ambient temperature around the unit.

Appearance of the outdoor unit may differ from some models.

■ Remote Controller

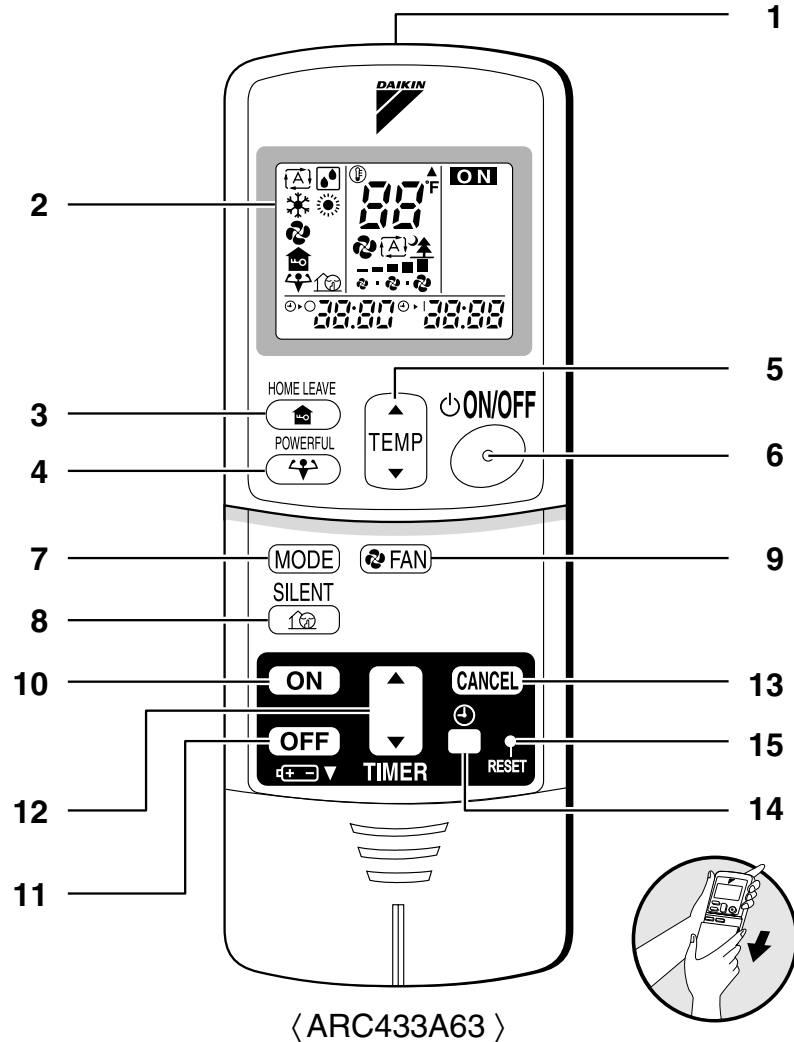

- | | |
|---|--|
| <p>1. Signal transmitter:</p> <ul style="list-style-type: none"> • It sends signals to the indoor unit. <p>2. Display:</p> <ul style="list-style-type: none"> • It displays the current settings.
(In this illustration, each section is shown with all its displays ON for the purpose of explanation.) <p>3. HOME LEAVE button:
HOME LEAVE operation (page 14.)</p> <p>4. POWERFUL button:
POWERFUL operation (page 12.)</p> <p>5. TEMPERATURE adjustment buttons:</p> <ul style="list-style-type: none"> • It changes the temperature setting. <p>6. ON/OFF button:</p> <ul style="list-style-type: none"> • Press this button once to start operation.
Press once again to stop it. | <p>7. MODE selector button:</p> <ul style="list-style-type: none"> • It selects the operation mode.
(AUTO/DRY/COOL/HEAT/FAN) (page 10.) <p>8. SILENT button: OUTDOOR UNIT SILENT operation (page 13.)</p> <p>9. FAN setting button:</p> <ul style="list-style-type: none"> • It selects the air flow rate setting. <p>10. ON TIMER button: (page 17.)</p> <p>11. OFF TIMER button: (page 16.)</p> <p>12. TIMER Setting button:</p> <ul style="list-style-type: none"> • It changes the time setting. <p>13. TIMER CANCEL button:</p> <ul style="list-style-type: none"> • It cancels the timer setting. <p>14. CLOCK button: (page 9.)</p> <p>15. RESET button:</p> <ul style="list-style-type: none"> • Restart the unit if it freezes. • Use a thin object to push. |
|---|--|

Preparation Before Operation

■ To set the batteries

1. Slide the front cover to take it off.
2. Set two dry batteries (AAA).
3. Set the front cover as before.

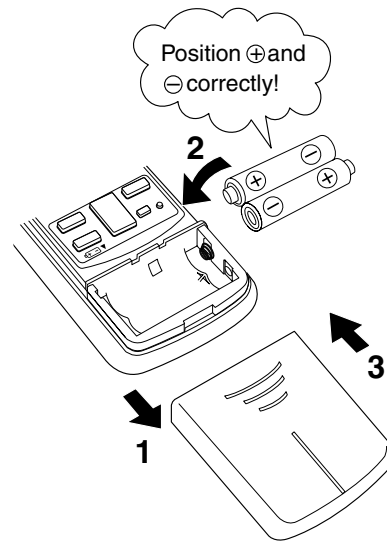

ATTENTION

■ About batteries

- When replacing the batteries, use batteries of the same type, and replace the two old batteries together.
- When the system is not used for a long time, take the batteries out.
- We recommend replacing once a year, although if the remote controller display begins to fade or if reception deteriorates, please replace with new alkali batteries. Do not use manganese batteries.
- The attached batteries are provided for the initial use of the system. The usable period of the batteries may be short depending on the manufactured date of the air conditioner.

Preparation Before Operation

■ To operate the remote controller

- To use the remote controller, aim the transmitter at the indoor unit. If there is anything to block signals between the unit and the remote controller, such as a curtain, the unit will not operate.
- Do not drop the remote controller. Do not get it wet.
- The maximum distance for communication is about 13ft.

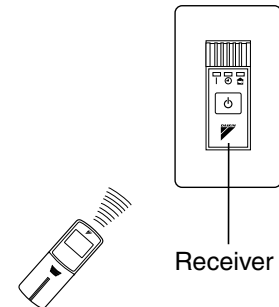

■ To fix the remote controller holder on the wall

1. Choose a place from where the signals reach the unit.
2. Fix the holder to a wall, a pillar, etc. with the screws supplied with the holder.
3. Place the remote controller in the remote controller holder.

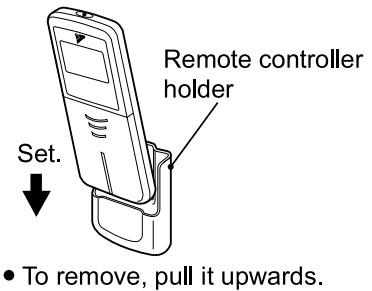

ATTENTION

■ About remote controller

- Never expose the remote controller to direct sunlight.
- Dust on the signal transmitter or receiver will reduce the sensitivity. Wipe off dust with soft cloth.
- Signal communication may be disabled if an electronic-starter-type fluorescent lamp (such as inverter-type lamps) is in the room. Consult the shop if that is the case.
- If the remote controller signals happen to operate another appliance, move that appliance to somewhere else, or consult the shop.

■ To set the clock

1. Press “CLOCK button”.

0:00 is displayed.

⌚ blinks.

2. Press “TIMER setting button” to set the clock to the present time.

Holding down “▲” or “▼” button rapidly increases or decreases the time display.

3. Press “CLOCK button”.

⌚ blinks.

■ Turn the breaker ON

- Turning ON the breaker opens the flap, then closes it again. (This is a normal procedure.)

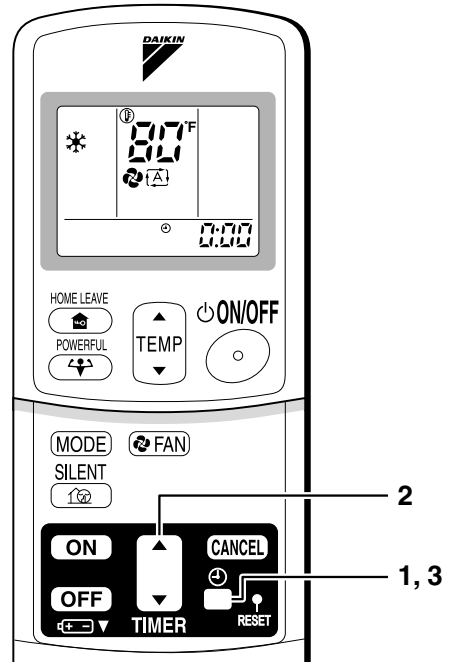

NOTE

■ Tips for saving energy

- Be careful not to cool (heat) the room too much. Keeping the temperature setting at a moderate level helps save energy.
- Cover windows with a blind or a curtain. Blocking sunlight and air from outdoors increases the cooling (heating) effect.
- Clogged air filters cause inefficient operation and waste energy. Clean them once every two weeks.

Recommended temperature setting	
For cooling:	78°F – 82°F
For heating:	68°F – 75°F

■ Please note

- The air conditioner always consumes 15-35 watts of electricity even while it is not operating.
- If you are not going to use the air conditioner for a long period, for example in spring or autumn, turn the breaker OFF.
- Use the air conditioner in the following conditions.

Mode	Operating conditions	If operation is continued out of this range
COOL	Outdoor temperature: 14 to 115°F Indoor temperature: 64 to 90°F Indoor humidity: 80% max.	<ul style="list-style-type: none"> • A safety device may work to stop the operation. • Condensation may occur on the indoor unit and drip.
HEAT	Outdoor temperature: 5 to 64°F Indoor temperature: 50 to 86°F	<ul style="list-style-type: none"> • A safety device may work to stop the operation.
DRY	Outdoor temperature: 14 to 115°F Indoor temperature: 64 to 90°F Indoor humidity: 80% max.	<ul style="list-style-type: none"> • A safety device may work to stop the operation. • Condensation may occur on the indoor unit and drip.

- Operation outside this humidity or temperature range may cause a safety device to disable the system.

AUTO · DRY · COOL · HEAT · FAN Operation

The air conditioner operates with the operation mode of your choice.
 From the next time on, the air conditioner will operate with the same operation mode.

■ To start operation

1. Press “MODE selector button” and select a operation mode.

- Each pressing of the button advances the mode setting in sequence.

- ☐A: AUTO
- ☐D: DRY
- ☐C: COOL
- ☐H: HEAT
- ☐F: FAN



2. Press “ON/OFF button”.

- The OPERATION lamp lights up.

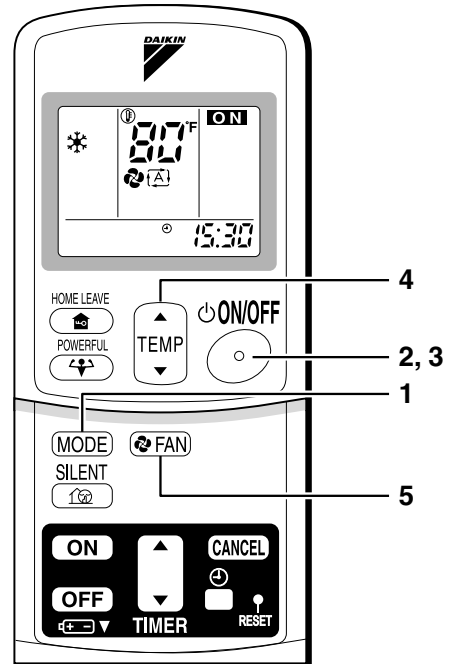
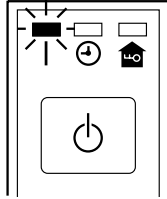

■ To stop operation

3. Press “ON/OFF button” again.

- Then OPERATION lamp goes off.





■ To change the temperature setting

4. Press “TEMPERATURE adjustment button”.

DRY or FAN mode	AUTO or COOL or HEAT mode
The temperature setting is not variable.	Press “▲” to raise the temperature and press “▼” to lower the temperature.
	Set to the temperature you like. 

■ To change the air flow rate setting

5. Press “FAN setting button”.

DRY mode	AUTO or COOL or HEAT or FAN mode
The air flow rate setting is not variable.	Five levels of air flow rate setting from “  ” to “  ” plus “  ” “  ” are available. 

- Indoor unit quiet operation

When the air flow is set to “”, the noise from the indoor unit will become quieter. Use this when making the indoor unit quieter.

The unit might lose capacity when the fan strength is set to a weak level.

NOTE

■ Note on HEAT operation

- Since this air conditioner heats the room by taking heat from outdoor air to indoors, the heating capacity becomes smaller in lower outdoor temperatures. If the heating effect is insufficient, it is recommended to use another heating appliance in combination with the air conditioner.
- The heat pump system heats the room by circulating hot air around all parts of the room. After the start of heating operation, it takes some time before the room gets warmer.
- In heating operation, frost may occur on the outdoor unit and lower the heating capacity. In that case, the system switches into defrosting operation to take away the frost.
- During defrosting operation, hot air does not flow out of indoor unit.

■ Note on COOL operation

- This air conditioner cools the room by blowing the hot air in the room outside, so if the outside temperature is high, performance drops.

■ Note on DRY operation

- The computer chip works to rid the room of humidity while maintaining the temperature as much as possible. It automatically controls temperature and fan strength, so manual adjustment of these functions is unavailable.

■ Note on AUTO operation

- In AUTO operation, the system selects a temperature setting and an appropriate operation mode (COOL or HEAT) based on the room temperature at the start of the operation.
- The system automatically reselects setting at a regular interval to bring the room temperature to user-setting level.
- If you do not like AUTO operation, you can manually select the operation mode and setting you like.

■ Note on air flow rate setting

- At smaller air flow rates, the cooling (heating) effect is also smaller.

POWERFUL Operation

POWERFUL operation quickly maximizes the cooling (heating) effect in any operation mode. You can get the maximum capacity.

■ To start POWERFUL operation

1. Press “POWERFUL button”.

- POWERFUL operation ends in 20 minutes. Then the system automatically operates again with the settings which were used before POWERFUL operation.
- When using POWERFUL operation, there are some functions which are not available.
- “” is displayed on the LCD.

■ To cancel POWERFUL operation

2. Press “POWERFUL button” again.

- “” disappears from the LCD.

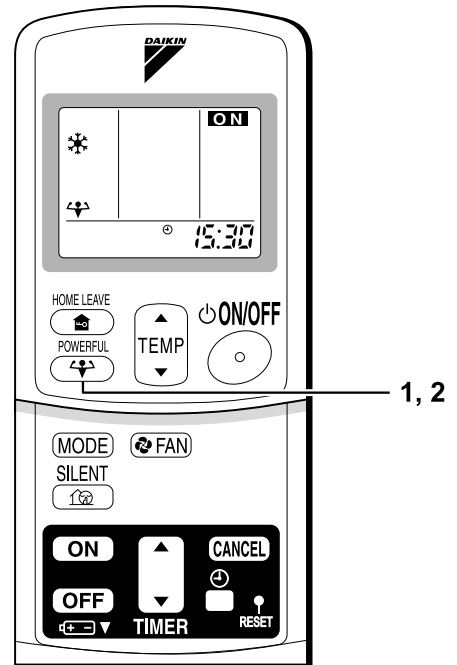

NOTE

■ Notes on POWERFUL operation

- POWERFUL Operation cannot be used together with SILENT Operation. Priority is given to the function of whichever button is pressed last.
- POWERFUL Operation can only be set when the unit is running. Pressing the operation stop button causes the settings to be canceled, and the “” disappears from the LCD.
- **In COOL and HEAT mode**
To maximize the cooling (heating) effect, the capacity of outdoor unit must be increased and the air flow rate be fixed to the maximum setting.
The temperature and air flow settings are not variable.
- **In DRY mode**
The temperature setting is lowered by 4.5°F and the air flow rate is slightly increased.
- **In FAN mode**
The air flow rate is fixed to the maximum setting.

OUTDOOR UNIT SILENT Operation

OUTDOOR UNIT SILENT operation lowers the noise level of the outdoor unit by changing the frequency and fan speed on the outdoor unit. This function is convenient during night.

■ To start OUTDOOR UNIT SILENT operation

1. Press “SILENT button”.

- “” is displayed on the LCD.

■ To cancel OUTDOOR UNIT SILENT operation

2. Press “SILENT button” again.

- “” disappears from the LCD.

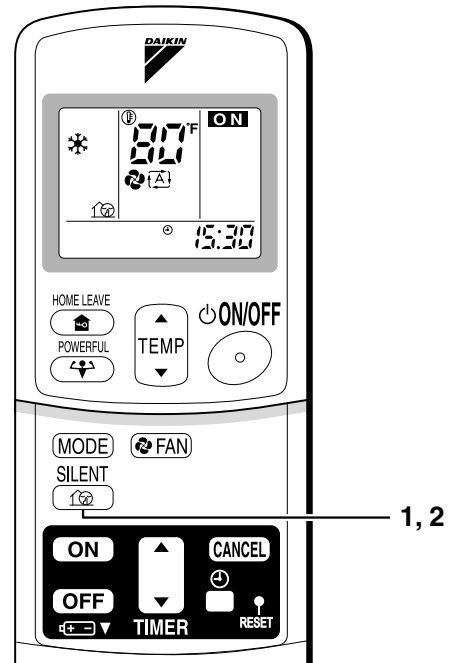

NOTE

■ Note on OUTDOOR UNIT SILENT operation

- This function is available in COOL, HEAT, and AUTO modes. (This is not available in FAN and DRY modes.)
- POWERFUL operation and OUTDOOR UNIT SILENT operation cannot be used at the same time. Priority is given to the function of whichever button is pressed last.
- If operation is stopped using the remote controller or the main unit ON/OFF switch when using OUTDOOR UNIT SILENT operation, “” will remain on the remote controller display.

HOME LEAVE Operation

HOME LEAVE operation is a function which allows you to record your preferred temperature and air flow rate settings.

■ To start HOME LEAVE operation

1. Press “HOME LEAVE button”.

- “” is displayed on the LCD.
- The HOME LEAVE lamp lights up.

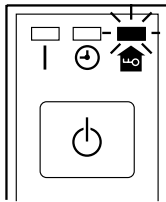

■ To cancel HOME LEAVE operation

2. Press “HOME LEAVE button” again.

- “” disappears from the LCD.
- The HOME LEAVE lamp goes off.

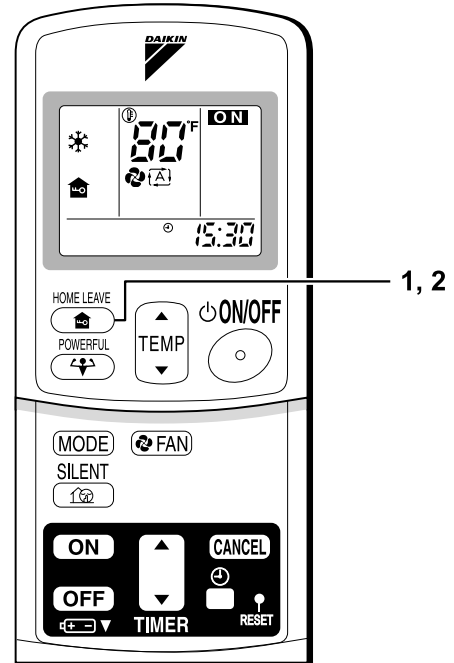

Before using HOME LEAVE operation.

■ To set the temperature and air flow rate for HOME LEAVE operation

When using HOME LEAVE operation for the first time, please set the temperature and air flow rate for HOME LEAVE operation. Record your preferred temperature and air flow rate.

	Initial setting		Selectable range	
	Temperature	Air flow rate	Temperature	Air flow rate
Cooling	77°F	AUTO	64-90°F	5 step, AUTO and SILENT
Heating	77°F	AUTO	50-86°F	5 step, AUTO and SILENT

1. Press “HOME LEAVE button”. Make sure “” is displayed in the remote controller display.
2. Adjust the set temperature with “▲” or “▼” as you like.
3. Adjust the air flow rate with “FAN” setting button as you like.

Home leave operation will run with these settings the next time you use the unit. To change the recorded information, repeat steps 1 – 3.

■ What's the HOME LEAVE operation?

Is there a set temperature and air flow rate which is most comfortable, a set temperature and air flow rate which you use the most? HOME LEAVE operation is a function that allows you to record your favorite set temperature and air flow rate. You can start your favorite operation mode simply by pressing the HOME LEAVE button on the remote controller. This function is convenient in the following situations.

■ Useful in these cases

1. Use as an energy-saving mode.

Set the temperature 4-5°F higher (cooling) or lower (heating) than normal. Setting the fan strength to the lowest setting allows the unit to be used in energy-saving mode. Also convenient for use while you are out or sleeping.

• Every day before you leave the house...



When you go out, push the "HOME LEAVE Operation" button, and the air conditioner will adjust capacity to reach the preset temperature for HOME LEAVE Operation.



When you return, you will be welcomed by a comfortably air conditioned room.



Push the "HOME LEAVE Operation" button again, and the air conditioner will adjust capacity to the set temperature for normal operation.

• Before bed...



Set the unit to HOME LEAVE Operation before leaving the living room when going to bed.



The unit will maintain the temperature in the room at a comfortable level while you sleep.

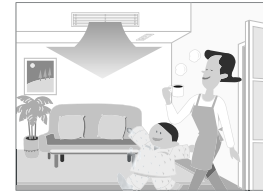

When you enter the living room in the morning, the temperature will be just right. Disengaging HOME LEAVE Operation will return the temperature to that set for normal operation. Even the coldest winters will pose no problem!

2. Use as a favorite mode.

Once you record the temperature and air flow rate settings you most often use, you can retrieve them by pressing HOME LEAVE button. You do not have to go through troublesome remote controller operations.

NOTE

- Once the temperature and air flow rate for HOME LEAVE operation are set, those settings will be used whenever HOME LEAVE operation is used in the future. To change these settings, please refer to the "Before using HOME LEAVE operation" section above.
- HOME LEAVE operation is only available in COOL and HEAT mode. Cannot be used in AUTO, DRY, and FAN mode.
- HOME LEAVE operation runs in accordance with the previous operation mode (COOL or HEAT) before using HOME LEAVE operation.
- HOME LEAVE operation and POWERFUL operation cannot be used at the same time. Last button that was pressed has priority.
- The operation mode cannot be changed while HOME LEAVE operation is being used.
- When operation is shut off during HOME LEAVE operation, using the remote controller or the indoor unit ON/OFF switch, "HOME LEAVE" will remain on the remote controller display.

TIMER Operation

Timer functions are useful for automatically switching the air conditioner on or off at night or in the morning. You can also use OFF TIMER and ON TIMER in combination.

■ To use OFF TIMER operation

- Check that the clock is correct. If not, set the clock to the present time. (page 9.)

1. Press “OFF TIMER button”.

0:00 is displayed.
 ○-○ blinks.

2. Press “TIMER Setting button” until the time setting reaches the point you like.

- Every pressing of either button increases or decreases the time setting by 10 minutes. Holding down either button changes the setting rapidly.

3. Press “OFF TIMER button” again.

- The TIMER lamp lights up.

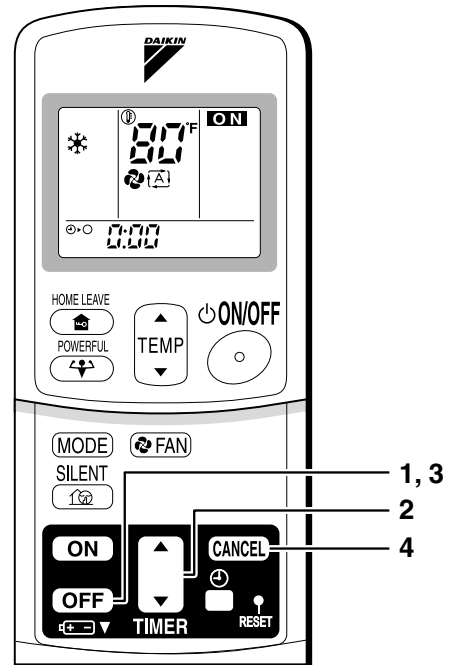
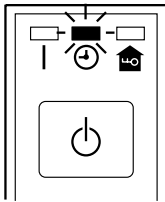

■ To cancel the OFF TIMER operation

4. Press “CANCEL button”.

- The TIMER lamp goes off.

NOTE

- When TIMER is set, the present time is not displayed.
- Once you set ON, OFF TIMER, the time setting is kept in the memory. (The memory is canceled when remote controller batteries are replaced.)
- When operating the unit via the ON/OFF Timer, the actual length of operation may vary from the time entered by the user. (Maximum approx. 10 minutes)

■ NIGHT SET MODE

When the OFF TIMER is set, the air conditioner automatically adjusts the temperature setting (1°F up in COOL, 4°F down in HEAT) to prevent excessive cooling (heating) for your pleasant sleep.

■ To use ON TIMER operation

- Check that the clock is correct. If not, set the clock to the present time. (page 9.)

1. Press “ON TIMER button”.

5:00 is displayed.

⊕/⊖ blinks.

2. Press “TIMER Setting button” until the time setting reaches the point you like.

- Every pressing of either button increases or decreases the time setting by 10 minutes. Holding down either button changes the setting rapidly.

3. Press “ON TIMER button” again.

- The TIMER lamp lights up.

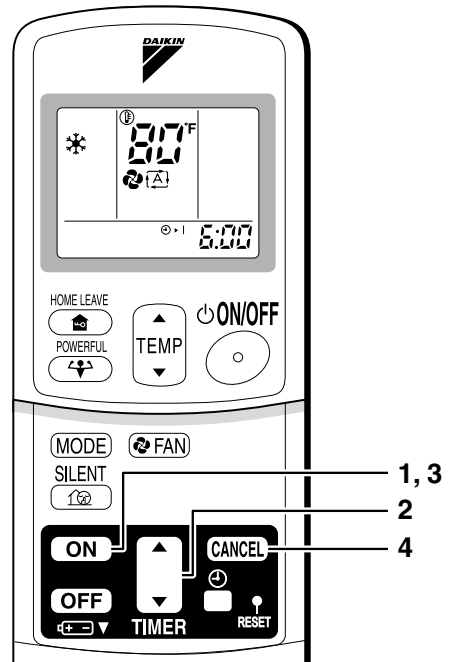
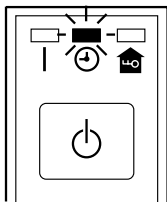

■ To cancel ON TIMER operation

4. Press “CANCEL button”.

- The TIMER lamp goes off.

■ To combine ON TIMER and OFF TIMER

- A sample setting for combining the two timers is shown below.

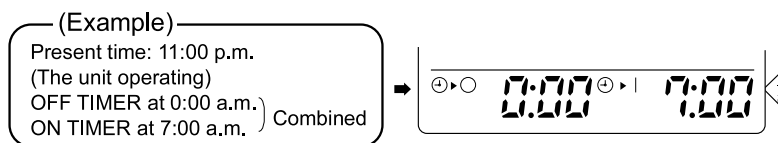

ATTENTION

■ In the following cases, set the timer again.

- After a breaker has turned OFF.
- After a power failure.
- After replacing batteries in the remote controller.

Care and Cleaning

- ⚠ CAUTION** • Only a qualified service person is allowed to perform maintenance.
 • Before cleaning, be sure to stop the operation and turn the breaker OFF.

■ Cleaning the air filter

1. Removing the air filter.

- Rear suction
Pull the bottom side of the air filter backwards, over the 2 bends.
- Bottom suction
Pull the filter over the 2 bends situated at the backside of the unit.

2. Cleaning the air filter.

Remove dust from the air filter using a vacuum cleaner and gently rinse them in cool water. Do not use detergent or hot water to avoid filter shrinking or deformation. After cleaning dry them in the shade.

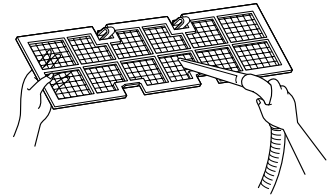

3. Replacing the air filter.

- Rear suction
Hook the filter behind the flap situated at the top of the unit and push the other side gently over the 2 bends.
- Bottom suction
Hook the filter behind the flap situated at the middle of the unit and push the other side gently over the 2 bends.

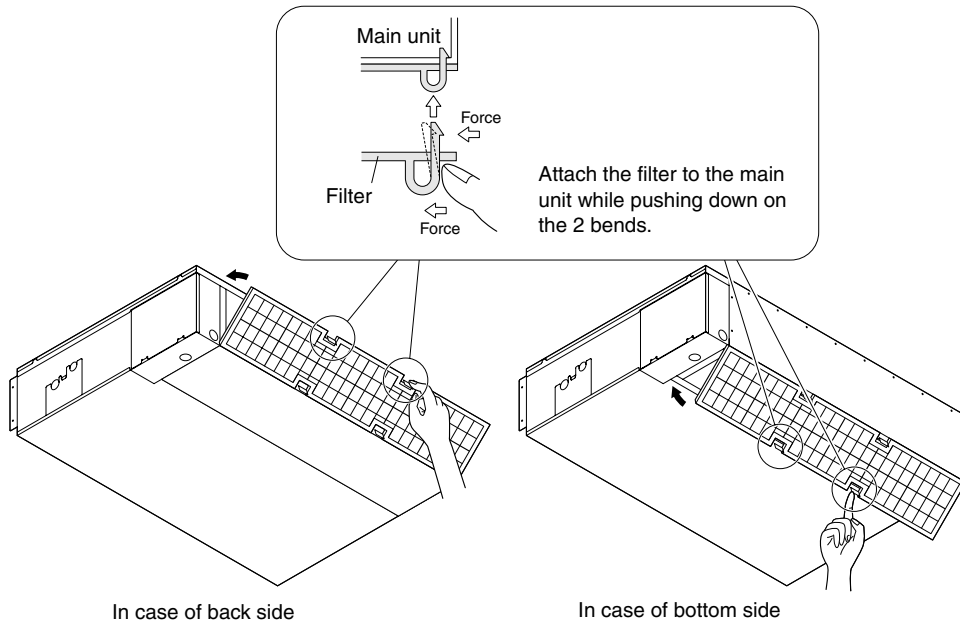

■ Cleaning the drain pan

- Clean the drain pan periodically, or drain piping may be clogged with dust and may result in water leakage. Ask your DAIKIN dealer to clean them.
- Prepare a cover locally to prevent any dust in the air around the indoor unit from getting in the drain pan, if there is a great deal of dust present.

CAUTION

- Do not operate the air conditioner without filters, this to avoid dust accumulation inside the unit.
- Do not remove the air filter except when cleaning. Unnecessary handling may damage the filter.
- Do not use gasoline, benzene, thinner, polishing powder, liquid insecticide. It may cause discoloring or warping.
- Do not let the indoor unit get wet. It may cause an electric shock or a fire.
- Operation with dusty air filters lowers the cooling and heating capacity and wastes energy.
- The suction grille is option.
- Do not use water or air of 122°F or higher for cleaning air filters and outside panels.
- Ask your DAIKIN dealer how to clean it.

Check

Check that the base, stand and other fittings of the outdoor unit are not decayed or corroded.
--

Check that nothing blocks the air inlets and the outlets of the indoor unit and the outdoor unit.

Check that the drain comes smoothly out of the drain hose during COOL or DRY operation.

- | |
|--|
| <ul style="list-style-type: none"> • If no drain water is seen, water may be leaking from the indoor unit. Stop operation and consult the service shop if this is the case. |
|--|

■ Before a long idle period

- 1. Operate the “FAN only” for several hours on a fine day to dry out the inside.**
 - Press “MODE selector button” and select “FAN” operation.
 - Press “ON/OFF button” and start operation.
- 2. Clean the air filters and set them again.**
- 3. Take out batteries from the remote controller.**
- 4. Turn OFF the breaker for the room air conditioner.**

Trouble Shooting

These cases are not troubles.

The following cases are not air conditioner troubles but have some reasons. You may just continue using it.

Case	Explanation
<p>Operation does not start soon.</p> <ul style="list-style-type: none"> • When ON/OFF button was pressed soon after operation was stopped. • When the mode was reselected. 	<ul style="list-style-type: none"> • This is to protect the air conditioner. You should wait for about 3 minutes.
<p>Hot air does not flow out soon after the start of heating operation.</p>	<ul style="list-style-type: none"> • The air conditioner is warming up. You should wait for 1 to 4 minutes. (The system is designed to start discharging air only after it has reached a certain temperature.)
<p>The heating operation stops suddenly and a flowing sound is heard.</p>	<ul style="list-style-type: none"> • The system is taking away the frost on the outdoor unit. • You should wait for about 3 to 8 minutes.
<p>The outdoor unit emits water or steam.</p>	<ul style="list-style-type: none"> ■ In HEAT mode <ul style="list-style-type: none"> • The frost on the outdoor unit melts into water or steam when the air conditioner is in defrost operation. ■ In COOL or DRY mode <ul style="list-style-type: none"> • Moisture in the air condenses into water on the cool surface of outdoor unit piping and drips.
<p>Mist comes out of the indoor unit.</p>	<ul style="list-style-type: none"> ■ This happens when the air in the room is cooled into mist by the cold air flow during cooling operation.
<p>The indoor unit gives out odour.</p>	<ul style="list-style-type: none"> ■ This happens when smells of the room, furniture, or cigarettes are absorbed into the unit and discharged with the air flow. (If this happens, we recommend you to have the indoor unit washed by a technician. Consult the service shop where you bought the air conditioner.)
<p>The outdoor fan rotates while the air conditioner is not in operation.</p>	<ul style="list-style-type: none"> ■ After operation is stopped: <ul style="list-style-type: none"> • The outdoor fan continues rotating for another 30 seconds for system protection. ■ While the air conditioner is not in operation: <ul style="list-style-type: none"> • When the outdoor temperature is very high, the outdoor fan starts rotating for system protection.
<p>The operation stopped suddenly. (OPERATION lamp is on.)</p>	<ul style="list-style-type: none"> ■ For system protection, the air conditioner may stop operating on a sudden large voltage fluctuation. It automatically resumes operation in about 3 minutes.

Check again.

Please check again before calling a repair person.

Case	Check
The air conditioner does not operate. (OPERATION lamp is off.)	<ul style="list-style-type: none"> • Hasn't a breaker turned OFF or a fuse blown? • Isn't it a power failure? • Are batteries set in the remote controller? • Is the timer setting correct?
Cooling (Heating) effect is poor.	<ul style="list-style-type: none"> • Are the air filters clean? • Is there anything to block the air inlet or the outlet of the indoor and the outdoor units? • Is the temperature setting appropriate? • Are the windows and doors closed? • Are the air flow rate and the air direction set appropriately?
Operation stops suddenly. (OPERATION lamp blinks.)	<ul style="list-style-type: none"> • Are the air filters clean? <p>Is there anything to block the air inlet or the outlet of the indoor and the outdoor units?</p> <p>Clean the air filters or take all obstacles away and turn the breaker OFF. Then turn it ON again and try operating the air conditioner with the remote controller. If the lamp still blinks, call the service shop where you bought the air conditioner.</p>
An abnormal functioning happens during operation.	<ul style="list-style-type: none"> • The air conditioner may malfunction with lightning or radio waves. Turn the breaker OFF, turn it ON again and try operating the air conditioner with the remote controller.

Call the service shop immediately.

 **WARNING**

- When an abnormality (such as a burning smell) occurs, stop operation and turn the breaker OFF.
Continued operation in an abnormal condition may result in troubles, electric shocks or fire.
Consult the service shop where you bought the air conditioner.
- Do not attempt to repair or modify the air conditioner by yourself.
Incorrect work may result in electric shocks or fire.
Consult the service shop where you bought the air conditioner.

If one of the following symptoms takes place, call the service shop immediately.

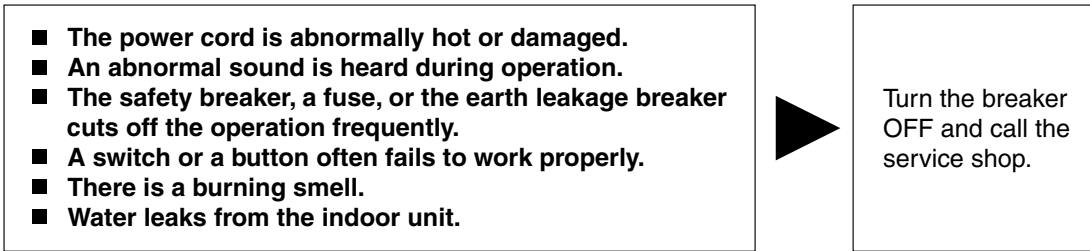

<ul style="list-style-type: none"> ■ After a power failure The air conditioner automatically resumes operation in about 3 minutes. You should just wait for a while. 	<ul style="list-style-type: none"> ■ Lightning If lightning may strike the neighbouring area, stop operation and turn the breaker OFF for system protection.
--	--

Disposal requirements

Dismantling of the unit, treatment of the refrigerant, oil and eventual other parts, should be done in accordance with the relevant local and national regulations. Contact your authorized dealer for assistance.

We recommend periodical maintenance.

In certain operating conditions, the inside of the air conditioner may get foul after several seasons of use, resulting in poor performance. It is recommended to have periodical maintenance by a specialist aside from regular cleaning by the user. For specialist maintenance, contact the service shop where you bought the air conditioner.
The maintenance cost must be born by the user.

Fault diagnosis.**FAULT DIAGNOSIS BY REMOTE CONTROLLER**

In the ARC433A series, the temperature display sections on the main unit indicate corresponding codes.

1. When the **TIMER CANCEL** button is held down for 5 seconds, a “00” indication flashes on the temperature display section.

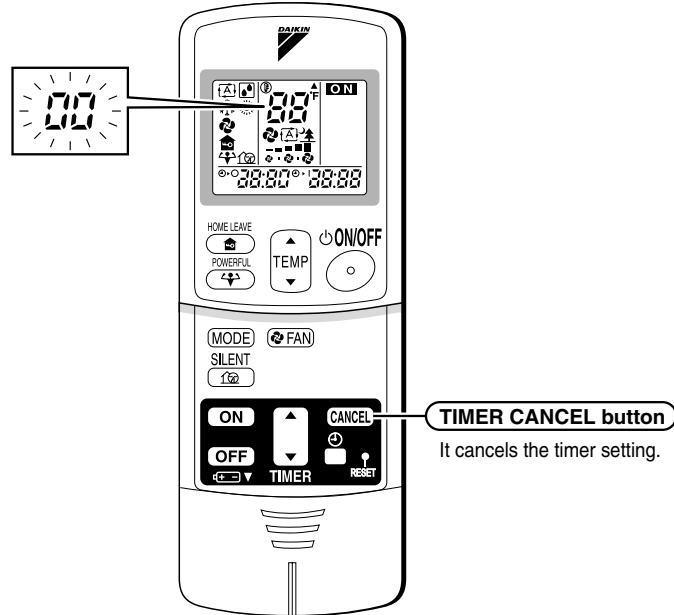

2. Press the **TIMER CANCEL** button repeatedly until a continuous beep is produced.

- The code indication changes in the sequence shown below, and notifies with along beep.

	CODE	MEANING
SYSTEM	00	NORMAL
	U0	REFRIGERANT SHORTAGE
	U2	DROP VOLTAGE OR MAIN CIRCUIT OVERVOLTAGE
	U4	FAILURE OF TRANSMISSION (BETWEEN INDOOR UNIT AND OUTDOOR UNIT)
INDOOR UNIT	A1	INDOOR PCB DEFECTIVENESS
	A5	HIGH PRESSURE CONTROL OR FREEZE-UP PROTECTOR
	A6	FAN MOTOR FAULT
	C4	FAULTY HEAT EXCHANGER TEMPERATURE SENSOR
OUTDOOR UNIT	C9	FAULTY SUCTION AIR TEMPERATURE SENSOR
	EA	COOLING-HEATING SWITCHING ERROR
	E5	OL STARTED
	E6	FAULTY COMPRESSOR START UP
	E7	DC FAN MOTOR FAULT
	E8	OPERATION HALT DUE TO DETECTION OF INPUT OVER CURRENT
	F3	HIGH TEMPERATURE DISCHARGE PIPE CONTROL
	F6	HIGH PRESSURE CONTROL (IN COOLING)
	H6	OPERATION HALT DUE TO FAULTY POSITION DETECTION SENSOR
	H8	CT ABNORMALITY
	H9	FAULTY SUCTION AIR TEMPERATURE SENSOR
	J3	FAULTY DISCHARGE PIPE TEMPERATURE SENSOR
	J6	FAULTY HEAT EXCHANGER TEMPERATURE SENSOR
	L4	HIGH TEMPERATURE AT INVERTER CIRCUIT HEATSINK
	L5	OUTPUT OVERCURRENT
P4	FAULTY INVERTER CIRCUIT HEATSINK TEMPERATURE SENSOR	

NOTE

1. A short beep and two consecutive beeps indicate non-corresponding codes.
2. To cancel the code display, hold the **TIMER CANCEL** button down for 5 seconds. The code display also cancel itself if the button is not pressed for 1 minute.

14. Optional Accessories

14.1 Option List

14.1.1 The Single Split Duct-Free System

	Option Name	FTXS09/12DVJU	FTXS15/18/24DVJU
1	Centralized Control Board-Up to 5 Rooms ★1	KRC72	
2	Wiring Adapter for Time Clock / Remote Control ★2 (Normal Open Pulse Contact / Normal Open Contact)	KRP413A1S	
3	Central Remote Controller ★1	DCS302C71	
4	Unified ON/OFF Controller ★1	DCS301C71	
5	Schedule Timer Controller ★1	DST301BA61	
6	Interface Adapter for Room Air Conditioner ★2	KRP928A2S	
7	Air Purifying Filter with Photocatalytic Deodorizing Function (with Frame)	KAF918A43	—
8	Air Purifying Filter with Photocatalytic Deodorizing Function (without Frame)	KAF918A44	—
9	Air Purifying Filter with Photocatalytic Deodorizing Function (without Frame)	—	KAF952A42
10	The Remote Controller Loss Prevention with the Chain	KKF917A4	

- Note:** ★1 Wiring adapter is also required for each indoor unit.
★2 Wiring adapter ; supplied by DAIKIN. Time clock and other devices ; obtained locally.

14.1.2 The Slim Duct Built-in System

	Option Name	FDXS09/12DVJU
1	Centralized Control Board-up to 5 Rooms ★1	KRC72
2	Wiring Adaptor for Time Clock/Remote Control ★2 (Normal Open Pulse Contact / Normal Open Contact)	KRP413A1S
3	Central Remote Controller ★1	DCS302C71
4	Unified ON/OFF Controller ★1	DCS301C71
5	Schedule Timer ★1	DST301BA61
6	Interface Adaptor for Room Air Conditioner ★2	KRP928A2S
7	Suction Grille	KDGF19A45
8	Insulation Kit for High Humidity	KDT25N32
9	Remote Controller Loss Prevention with the Chain	KKF917A4

- Note:** ★1 Wiring adapter is also required for each indoor unit.
★2 Wiring adapter ; supplied by DAIKIN. Time clock and other devices ; obtained locally.

14.1.3 Outdoor Units

	Option Name	RXS09/12DVJU	RXS15/18/24DVJU
1	Drain Plug	KKP937A4	
2	Air Direction Adjustment Grille	KPW937A4	—
3	Air Direction Adjustment Grille	—	KPW945A4



- Note:** ★1 Wiring adapter is also required for each indoor unit.
★2 Wiring adapter ; supplied by DAIKIN. Time clock and other devices ; obtained locally.

14.2 Installation Manual



14.2.1 KRP413A1S

Safety Precautions

- Read these safety precautions carefully before installing the unit, and be sure to install the unit properly.
- This manual classifies precautions to the user into the following two categories. These warnings and cautions are for your safety. Follow them.

 WARNING	Faulty installation can result in death or serious injury.
 CAUTION	Faulty installation can result in serious injury, damage to property, or other serious consequences.

- Below is a key to symbols used in this manual.

	Be sure to follow instructions.
	Be sure to perform grounding work.
	Never attempt.

- After installation is complete, test the unit to confirm that it is working properly, and instruct the owner its proper use.

WARNING

- Installation should be left to the dealer from whom you purchased the unit, or another qualified professionals.
- Install the unit securely according to the installation manual. Faulty installation may lead to electric shock or fire.
- Be sure to use the supplied or specified parts. Using other parts may lead to electric shock or fire.
- Install the unit securely in a location that will support its weight. If installed in a poor location or improperly installed, the unit may not work as intended.
- For electrical work, follow local electric standards and the installation manual. Faulty installation may lead to fire or electric shock.
- Do not bundle the power cord, or attempt to extend it by splicing it with another cord or by using an extension cord. Do not place any other load on the power circuit used for the unit. Improper wiring may lead to electric shock, heat generation or fire.
- Use dedicated wiring for all electrical connections, and be sure to arrange the wiring so that force applied to the wiring will not damage the terminals. Poor wiring or installation may cause electric shock, heat generation or fire.

CAUTION

- Before installation, unplug the air conditioner to ensure safety. Failure to do so may cause electric shock.
- Static electricity may damage electric components. Before connecting cables and communication lines, and operating the switches, be sure to discharge any electrical charge from your body (by, for example, touching the earth line)
- Do not install the unit in a location where it may be exposed to flammable gases. If gas leaks and build up around the unit, it may catch fire.
- Do not place the relay harness close to the power cord, inter-unit cable, or pipes which generate noise. Treat the harness with care.

1. Functions and Features

- On/Off setting
- Switching between Instantaneous Contact/Normal Contact
- Connection with five-room central controller (KRC72 for oversea model)
- Connection with fan coil remote controller
- Automatic reset after power failure
- Output of normal operation signals/alert signals

2. Field Wiring

For interconnecting wiring, use Daikin KDC100A12 cable (not supplied) or other similar cable. The cable should have the specifications shown below.

■ Optional cable KDC100A12 (without connectors)

Specifications: 0.2 mm² × 4 core (sheathed)
 Outer diameter: φ5.3
 Length: 100 m
 Colour: Grey

■ Other cable (commercially available)

Item	Outer dia.	Remarks
Cable for instrumentation (IPVV) 0.3 mm ² × 4-core	7.2 mm	Hard sheath
Microphone cord (MVVS) 0.3 mm ² × 4-core	8.0 mm	Shielded
Microphone cord (MVVS) 0.2 mm ² × 4-core	6.5 mm	
Microphone cord (MVVS) 0.15 mm ² × 4-core	4.8 mm	
Intercom cable 0.65 mm ² dia. × 4-core		
PVC jumper wire (TJVC) (from 0.5 mm dia. × 4 pcs.)	–	Not sheathed

Note 1: Keep any wiring for the control unit away from the power cord to prevent electrical noise.

Note 2: Do not use cables shown above for power cord, inter-unit cord/cable or power cord for lamps.

Installation

This product is available in two types. The **KRP413A1S** is for installation in a case independent of the indoor unit, and the **KRP413A1** is for installation within the indoor unit.

1. KRP413A1S

1 Installation diagram

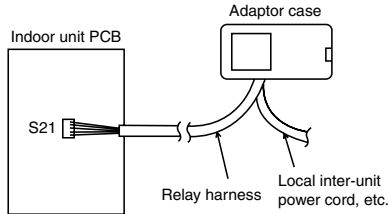

2 Components

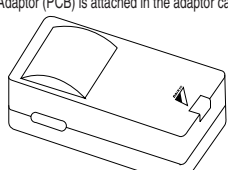
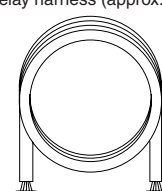
<p>① Adaptor case assy (Adaptor (PCB) is attached in the adaptor case.)</p> 	<p>② Relay harness (approx. 0.8 m)</p> 
<p>③ Accessories</p> <ul style="list-style-type: none"> • Tie-wrap (4 pcs.) • Velcro for attaching to the indoor unit (2 sets) • Screws for attaching the adaptor case (4 pcs.) • Screws for attaching to the wall (3 pcs.) 	
<p>④ Installation manual</p>	

2. KRP413A1

For this type, install the adaptor PCB within the indoor unit. The method of installation and connection vary depending on the model of the air conditioner. See your air conditioner installation manual for details.

1 Components

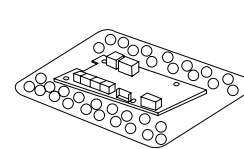
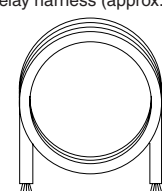
<p>① Adaptor PCB</p> 	<p>② Relay harness (approx. 0.25 m)</p> 
<p>③ Installation manual</p>	

3. Attaching Adaptor Case Assy (for KRP413A1S)

1 Using the screws (to mount on a wall, etc.)

- Use the 3 supplied screws to attach the case assy .

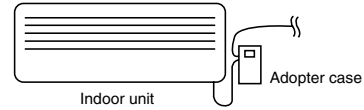

- Install the adaptor case assy as close to the indoor unit as possible.
- ① Removing case front

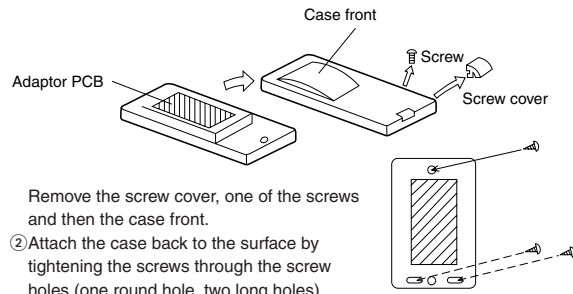

- Remove the screw cover, one of the screws and then the case front.
- ② Attach the case back to the surface by tightening the screws through the screw holes (one round hole, two long holes).
 - ③ After connecting the cables (refer to the following sections), replace the case front. Be careful not to damage the harness in the case.

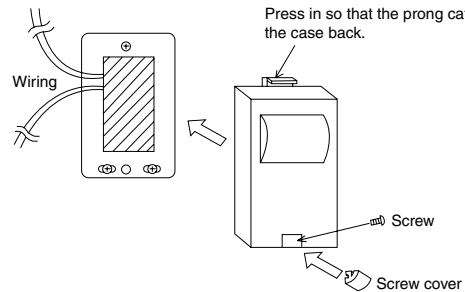

2 Using Velcro (to attach on the indoor unit)

- Attach the adaptor case with the supplied Velcro.
- ① Remove the case front (as for mounting on a wall).
 - ② After connecting the cables (see the following sections), replace the case front. It can be screwed to the case back from the rear with the four supplied screws. Be careful not to damage the harness in the case.
 - ③ Stick one end of the Velcro to the rear side of the case back, and stick the other end to the indoor unit with the same space between them.

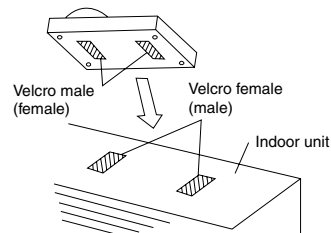

To prevent the adaptor case assy from falling, do not use the Velcro for attaching it to a wall or other surface.

Wiring

1. Wiring

- ① Connect one end of the relay harness to connector S21 of the PCB in the indoor unit.
- ② Connect the other end of the relay harness to connector S6 of the adaptor PCB.
- ③ Connect field wiring according to the functions assigned to each connection terminal of the adaptor PCB.
- ④ Secure all wires.

1 Securing wires in the adaptor case assy (for KRP413A1S)

- Fasten with a tie-wrap so that wires will not come loose even if pulled.

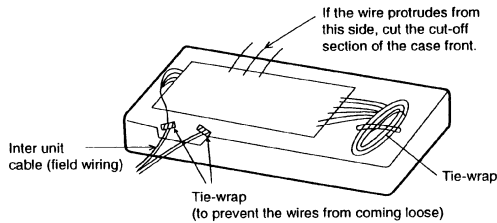

2 Securing wires in the indoor unit (for KRP413A1)

- The method for securing wire varies depending on the model of the air conditioner. See your air conditioner installation manual for details.

2. Automatic Reset After Power Failure

- This PCB stores the following data in the event of a power failure (common features).
 - ① On/Off (see Note 1)
 - ② Operation modes
 - ③ Temperature setting
 - ④ Air flow rate
 - ⑤ On/Off status of remote controller
 (Note 1 When SW1-2 is in Off mode, the unit will not be activated.)

3. Monitor Signal Output (normal operation and malfunction)

- Maximum length of the wiring is 100 m.

1 Monitor signal output for LED

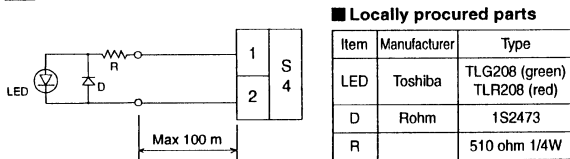

2 Monitor signal output (normal operation and malfunction) using external relay contacts

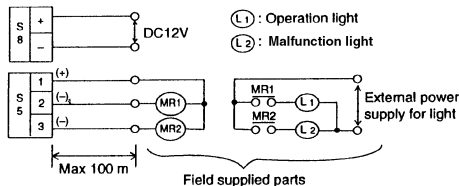

Field procured parts (Recommended external relay contacts)

Manufacturer	Type	Coil rated voltage	Coil resistance
Omron	MY relay	12 V DC	160 ohm ± 10%
Matsushita	HC relay	12 V DC	160 ohm ± 10%

4. Connection with Remote Controller

Example connections with three kinds of remote controllers are shown below.

Note: These connections cannot be used in combination.

1 Generic remote controller

- Set SW1-1 to Off and select Operation Mode 1.



<Instantaneous Contact>

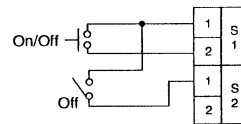

- The remote controller most recently used (local or air conditioner) takes precedence.
- Use a remote controller with a pulse width of 100 msec or more.

<Normal Contact>

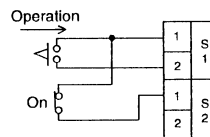

- Power On/Off cannot be controlled from the unit's remote controller.
- When power is restored after a power failure in this mode, On or Off is determined according to the current settings of the remote controller.

2 Five-room central controller (KRC72)

- Set SW1-1 to Off and select Operation Mode 1.
- The remote controller most recently used takes precedence.

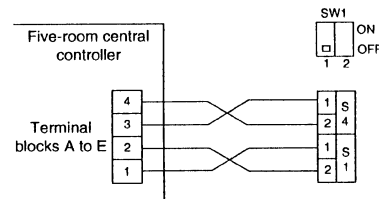

3 Fan coil remote controller

- Set SW1-1 to On and select Operation Mode 2.
- Most settings (power On/Off, air flow rate, mode change) cannot be made using the air conditioner's remote controller.
- When power is restored after a power failure in this mode, On or Off is determined according to the current settings of the remote controller.
- When the Cooling /Heating mode is changed, use the air conditioner's remote controller to adjust the temperature.

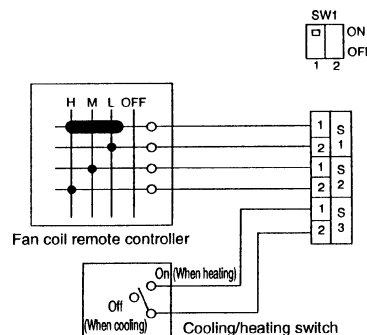

Test Operation and Confirmation

1 When the System is Not Working

- Is the air conditioner working properly?
- Are the connectors of the relay harness properly connected?
- Are the remote controller and field wiring properly connected?
- Are all switch settings correct?
- If there is nothing apparently wrong, conduct a diagnostic check using the following procedure.

■ Diagnostic check

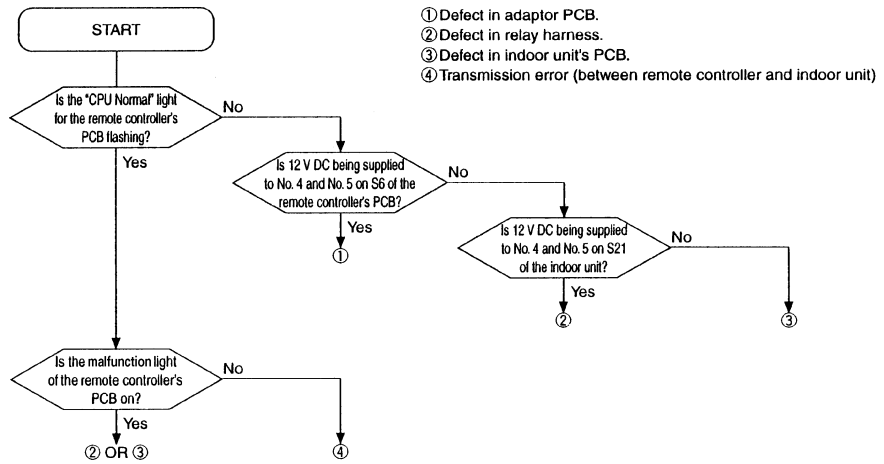

2. Switch Settings and Connection Terminals

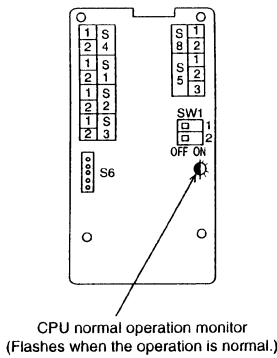

SW1-1	Selecting the operation mode	OFF	Operation mode 1 (Used with the exception of fan coil remote controller settings)			
		ON	Operation mode 2 (Used with fan coil remote controller settings)			
SW1-2	Selecting On/Off when power is restored after a power failure	OFF	Always Off			
		ON	Off if operation was in Off mode before power failure; On if operation was in On mode before power failure			
S1 S2 S3	SW1-1: OFF (Operation mode 1)			Instantaneous contact	Normal contact	
		S1 (1) - S2 (1)	OPEN	CLOSE		
		S1 (1) - S1 (2)	Pulse input On/Off switching		OPEN, Not activated CLOSE, Activated	
		S2 (2), S3	Not used			
	SW1-1: ON (Operation mode 2)	S1, S2 OPEN		Not activated		
		S1 (1) - S1 (2) CLOSE		On, airflow: L tap		
		S1 (1) - S2 (1) CLOSE		On, airflow: M tap		
		S1 (1) - S2 (2) CLOSE		On, airflow: H tap		
S3 (With the remote controller only)			OPEN, Cooling			
			CLOSE, Heating			
S4	(1) - (2)	Voltage on (DC12 V), normal operation light output				
S5	(1) - (2)	Normal operation light output (power for light required)				
	(1) - (3)	Malfunction light output (power for light required)				
S6 connector		Connect with connector S21 on the PCB of the indoor unit				
S8	(+) - (-)	Relay DC 12 V power supply terminal (Field supplied parts)				

14.2.2 KRP928A2S

Safety Precautions

- Read these Safety Precautions carefully to ensure correct installation.

This manual classifies precautions into WARNING and CAUTION.

WARNING : Failure to follow WARNING is very likely to result in such grave consequences as death or serious injury.

CAUTION : Failure to follow CAUTION may result in serious injury or property damage, and in certain circumstances, may result in a grave consequence.

Be sure to follow all the precautions below ; they are all important for ensuring safety.

WARNING

- **Installation should be left to the dealer or another qualified professional.**
Improper installation by yourself may cause malfunction, electrical shock, or fire.
- **Install the set according to the instructions given in this manual.**
Incomplete or improper installation may cause malfunction, electrical shock, or fire.
- **Be sure to use the standard attachments or the genuine parts.**
Use of other parts may cause malfunction, electrical shock, or fire.
- **Disconnect power to the connected equipment before starting installation.**
Failure to do so may cause malfunction, electrical shock, or fire.

CAUTION

- **An earth leakage circuit breaker should be installed.**
If the breaker is not installed, electrical shock may occur.
- **Do not install the set in a location where there is danger of exposure to inflammable gas.**
Gas accumulated around the unit at the worst may cause fire.
- **To prevent damage due to electrostatic discharge, touch your hand to a nearby metal object (doorknob, aluminum sash, etc.) to discharge static electricity from your body before touching this kit.**
Static electricity can damage this kit.
- **Lay this cable separately from other power cables to avoid external electrical noises.**

- After installation is complete, test the operation of the PCB set to check for problems, and explain how to use the set to the end-user.

1. Overview, Features and Compatible Models

This kit is an interface necessary for the connection of central control equipment to a room air conditioner, and can operate and monitor the things mentioned below in combination of central control equipment. This kit copes with the room air conditioner with HA terminal S21.

- Operation, stop, changeover of operation mode and setting temperature are carried out from a central control equipment. (18-32°C in cooling, 14-28°C in heating, no blow mode)
- Operation state, existence of abnormality and abnormal phenomena are monitored from a central control equipment.
- A central control equipment, a card key restricts the operation by a remote controller such as starting, stop, operation mode changeover and setting temperature.
- Zone control through a central control equipment.
- When power failure occurs, it returns to the operation before the power failure.
- Monitoring the operation and stop through devices complied with HA JEM-A (Tele-con kit).

This kit does not support the following controls.

- Group control (control of plural indoor units by one remote controller).
- Monitoring the following items.
Room temperature/ thermostat condition/ compressor operation state/ indoor fan operation state/electric heater and humidifier operation state.
- Controlling the following items.
Forced thermostat off/ filter sign display and reset/air flow direction and air flow rate/air conditioning charge management.
- Save energy command/Low noise command/"Demand" command.

2. Components

This kit includes the following components. Check to ensure that none of these are missing.

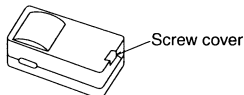

Parts	Q'ty	Parts	Q'ty
Kit assembly	1	Connection harness with connector	1set
PCB is in the housing.		Mounting screws	3pcs.
		Binding band	1pc.
		Double-sided tape	2pcs.
		Installation manual	1set

3. Initial Setting

Put initial setting of each switch on the PCB after the casing of this kit is opened. (Set it to ■)

① Settings for overseas and Japanese models (SW3)

The setting is required for room air conditioners because the temperature setting in Auto Mode differs between overseas models and Japanese ones.

SW3	Setting
	When connecting to Japanese models. (Delivery setting) Auto Mode cannot be selected from central control equipment. When Auto Mode is selected using the remote controller, Auto cooling or Auto heating is displayed at the central remote controller. (At this time, the temperature display is fixed at 25°C)
	When connecting to overseas models. Auto Mode can be selected from central control equipment. When Auto Mode is selected using the remote controller, Auto Cooling or Auto Heating is displayed on the central remote controller.

② Setting group numbers (SW1, SW2-1 to 3)

Set it as shown in the table below. The same number should not be set for two units or more.

SW2 setting groupNO.	Upper groupNO.	SW1 setting groupNO.	Lower groupNO.	SW1 setting groupNO.	Lower groupNO.
1	1	0	0	0	8
0	2	0	1	0	9
	3	0	2	0	10
	4	0	3	0	11
	5	0	4	0	12
	6	0	5	0	13
	7	0	6	0	14
	8	0	7	0	15

③ Auto restart ON/OFF (SW2-4)

In case that the switch is ON, the unit returns to the original operation before power failure when the power failure is canceled. In case that the switch is OFF, the unit is secure to stop when the power failure is canceled. When an auto restart ON/OFF jumper is provided in the indoor unit, control from this kit takes priority. The following status information is stored regardless of on/off state. (Operation mode, Set temperature, Rejection of remote controller)

4. Gist of wiring

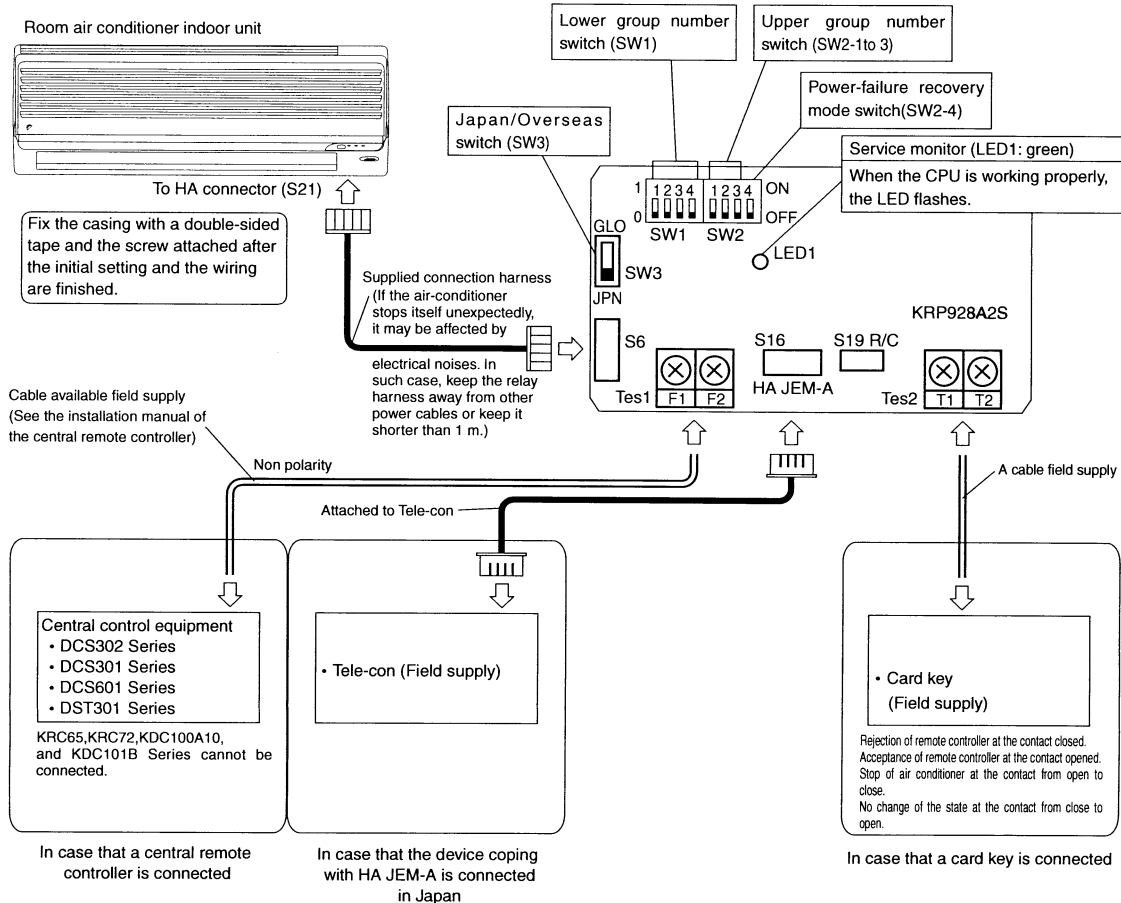

■ Control code

When the central remote controller is used, the operation code and the rejection on remote controller of room air conditioner are as follows. (The device coping with HA JEM-A is not restricted)

Remote controller operation mode	Tes 2	Control code	Control by remote controller	
			Unified operation, individual operation by central remote controller, or operation controlled by timer	Unified stop, individual stop by central remote controller, or timer stop
ON/OFF control is rejected by remote controller	open	0 1 3	ON/OFF operation, timer setting is not possible	
		10 11	Only air flow and air direction can be set	
Only OFF control is accepted by remote controller	open	2 12~19	Only off operation, air flow and air direction can be set	
Central priority	open	4	Last command takes priority	Only off operation, air flow and air direction can be set
		5	Last command takes priority	ON/OFF operation, timer setting is not possible
Last command priority	open	6 7	Last command takes priority	
Timer operation is accepted by remote controller	open	8	Last command takes priority (only operation controlled by timer)	Only off operation, air flow and air direction can be set
		9	Last command takes priority (only operation controlled by timer)	ON/OFF operation, timer setting is not possible
Forced stop	close	0~19	Not possible	

■ The devices possible to combine are shown below.

	Card key	Device coping with HA JEM-A	Schedule timer	Central controller	Wireless remote controller
Card key	×	○	○	○	○
Device coping with HA JEM-A	○	×	○	○	○
Schedule timer	○	○	×	○	○
Central controller	○	○	○	×	○
Wireless remote controller	○	○	○	○	×

14.2.3 KDGF19A45

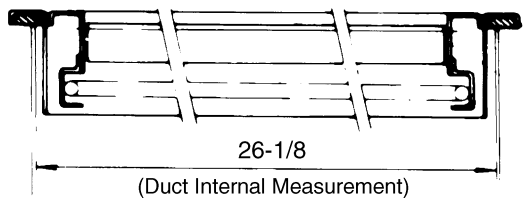
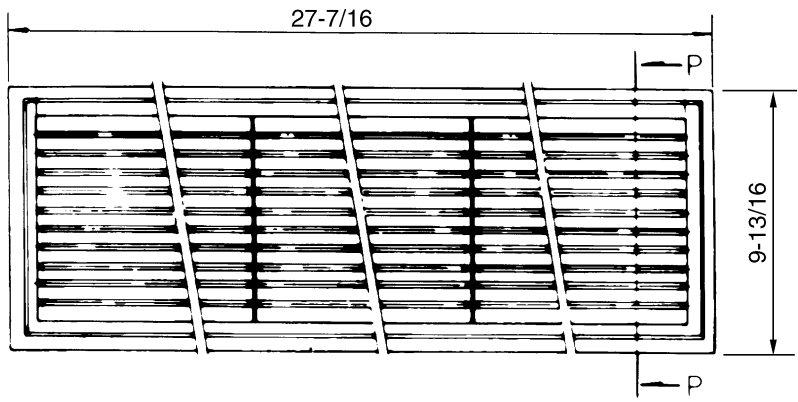

Note: Paint color : Ivory white

Unit: inch

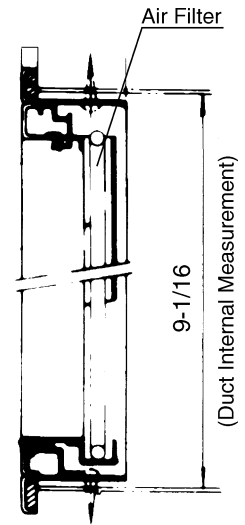

Section P - P

14.2.4 KDT25N32

Caution				
<ul style="list-style-type: none"> • This kit can be installed to the Ceiling mounted Built-in Type Air Conditioners. <Slim duct type> • When the Installation box for adapter PCB(KPP1B101) is used together, mount this kit before Installation box. • It is recommended to mount this kit before installing the indoor unit. 				
Combination table				
The indoor unit model applied		Kit name		
KDT25N32		KDT25N50		
Room Air Conditioners	CDK(X)D(S)25 • 35EAVM(A)(T)	CDK(X)D(S)25 • 35 • 50C(D)VM(A)(T)	CDK(X)D(S)60C(D)VM(A)(T)	
VRV	FXD(Q)20 • 25 • 32PVE(T)(5)	FXD(Q)20 • 25 • 32 • 40 • 50M(N)VE(T)(5)	FXD(Q)63M(N)VE(T)(5)	
Details of parts				
Designation	① Top plate insulation (T-1)	② Top plate insulation (T-2)	③ Side plate insulation (S-1)	④ Side plate insulation (S-2)
Shape				
Number of pieces	1	1	2	1
Designation	⑤ Bottom plate insulation (B-1)	⑥ Chamber cover insulation (C-1)		
Shape				
Number of pieces	1	1		
Designation	⑦ Hanger (right) insulation (H-1)	⑧ Hanger (left) insulation (H-2)	⑨ Installation manual	
Shape				
Number of pieces	1	1	1	

1 How to attach When moving the unit at or after opening, hold the unit by the hanger brackets. Do not apply force to the refrigerant piping, drain piping or flange parts.

<Procedure> Stick the insulations carefully according to the following procedures and do not make a gap between the adjacent thermal insulations.

- (1) Stick the top plate insulation (T-1) (T-2) to the indoor unit top plate.
- (2) Cut off the side plate insulation (S-1) following the score. (See the right figure)
- (3) Stick the side plate insulation (S-1) to the indoor unit right side plate.
- (4) Stick the side plate insulation (S-1) to the indoor unit left side plate without cutting off the area surrounded by the score.
- (5) Stick the side plate insulation (S-2) to the indoor unit left side plate.
- (6) Stick the bottom plate insulation (B-1) to the indoor unit bottom plate.
- (7) Stick the chamber cover insulation (C-1) to the indoor unit chamber cover.
- (8) Stick the hanger (left) insulation (H-2) and the hanger (right) insulation (H-1) respectively to the left and right hangers respectively. (See the right figure for the sticking base line.)

Cut off the area shown with oblique lines and throw it away.

VRV model only

VRV and Room Airconditioners

KDT25N50, KDT25N63 model only

ARROW VIEW A

DETAIL B

DETAIL C



3P131323-1C

14.2.5 KPW937A4

■ Before Installation

Checking the parts

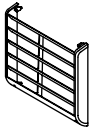
Check the following parts

Name	Louver	Installation manual
Shape		
	With 4 screws	
Quantity	1 piece	1 piece

■ Installation Procedure

Selection of Installation Location

Use when installing in a location that meets the following conditions.

- When installing near the border to a neighbor's house
- If exhaust blows directly on passers-by because outdoor unit is installed facing a road.
- Changing the fan direction of the outdoor unit to prevent it blowing directly on shrubbery, etc.

Installation of Louver

- Installation is possible in the four directions: upward, downward, rightward, and leftward.
- The installation screws are attached to the louver.
- First temporarily attach the louver with 4 screws, then check that the angle is correct, and finally tighten the screws fully.

CAUTION

1. Install so that a short circuit is prevented.
2. For the use in snowy regions, avoid installation with the air outlet facing upward. Install so that the air outlet faces leftward, rightward, or downward. Snow accumulates in the air outlet of the outdoor unit, causing malfunction of the main body of the outdoor unit.
3. Be advised that if the fan direction is up, dead leaves and other foreign matter easily accumulates in the exhaust vent.

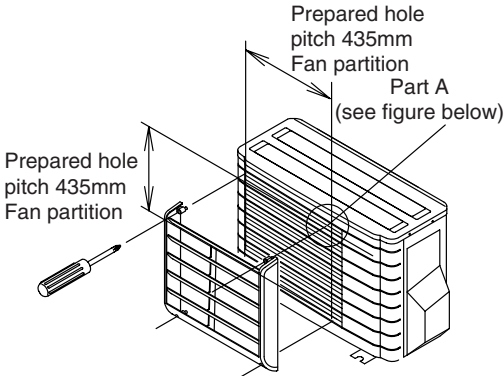

The prepared hole is in between the grating of the grille. Part A (prepared hole) cross section (the shape of either a or b)



a) Grille grating b) Grille grating



4P104499-1

14.2.6 KPW945A4

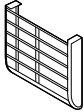
■ Before installation

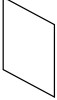
Check the following parts	Name	Louver	Truss tap-in screw	Installation manual
	Shape			
	Quantity	1 piece	M4x4 screws(max.7.5kW class) M5x4 screws(8.0/9.0kW class)	1 piece

■ Installation Procedure

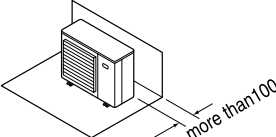
Selection of Installation Location	Space Needed for Installation
<p>Use when installing in a location that meets the following conditions.</p> <ul style="list-style-type: none"> • When installing near the border to a neighbor's house • If exhaust blows directly on passers-by because outdoor unit is installed facing a road. • If exhaust blows directly on vegetation 	<ul style="list-style-type: none"> • A minimum of 100mm is needed between the back of the outdoor unit and any obstructions (walls, etc.) 

Installation of Louvers

⚠ Caution

Attach the louvers overlapping the standard grill.
Installing the louvers without the grill would allow hands to enter the fan area, which is dangerous, so be sure to install the standard grill.

When pointing up

- (1) Remove the 4 attachment screws from the standard grill.

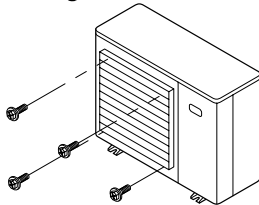

- (2) Install the louver pointed up.

- Overlap the standard grill and screw both in together.
- The attachment screws are in the louvers.

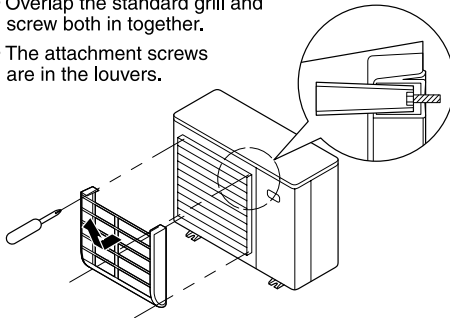

- (3) Installation complete

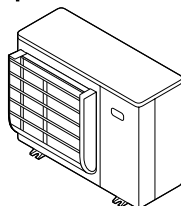

When pointing down

- (1) Remove the 4 attachment screws from the standard grill.

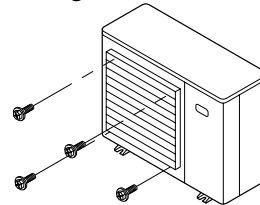

- (2) Install the louver pointed down.

- Overlap the standard grill and screw both in together.
- The attachment screws are in the louvers.

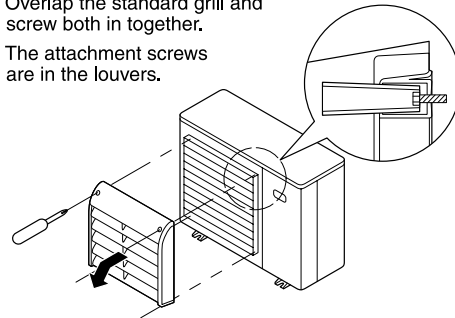

- (3) Installation complete

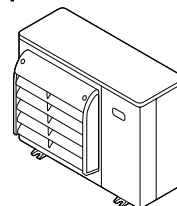

Warnings



- Always use a licensed installer or contractor to install this product. Do not try to install the product yourself. Improper installation can result in water or refrigerant leakage, electrical shock, fire or explosion.
- Use only those parts and accessories supplied or specified by Daikin. Ask a licensed contractor to install those parts and accessories. Use of unauthorized parts and accessories or improper installation of parts and accessories can result in water or refrigerant leakage, electrical shock, fire or explosion.
- Read the User's Manual carefully before using this product. The User's Manual provides important safety instructions and warnings. Be sure to follow these instructions and warnings.

For any inquiries, contact your local Daikin sales office.



© 2004 Daikin Industries, Limited.



The air conditioners manufactured by Daikin Industries have received **ISO 9001** certification for quality assurance.

Certificate Number.
(ISO9001) JMI-0107
JQA-0495
JQA-1452



All Daikin Industries locations and subsidiaries in Japan have received environmental management system standard **ISO 14001** certification.

Daikin Industries, Ltd.
Domestic Group
Certificate Number. EC99J2044

About ISO 14001

ISO 14001 is the standard defined by the International Organization for Standardization (ISO) relating to environmental management systems. Our group has been acknowledged by an internationally accredited compliance organisation as having an appropriate programme of environmental protection procedures and activities to meet the requirements of ISO 14001.

Dealer

DAIKIN AC (AMERICAS), INC.

1645 Wallace Drive, Suite 110
Carrollton, TX 75006

info@daikinac.com
www.daikinac.com

©All rights reserved

•The specifications, designs, and information in this brochure are subject to change without notice.